

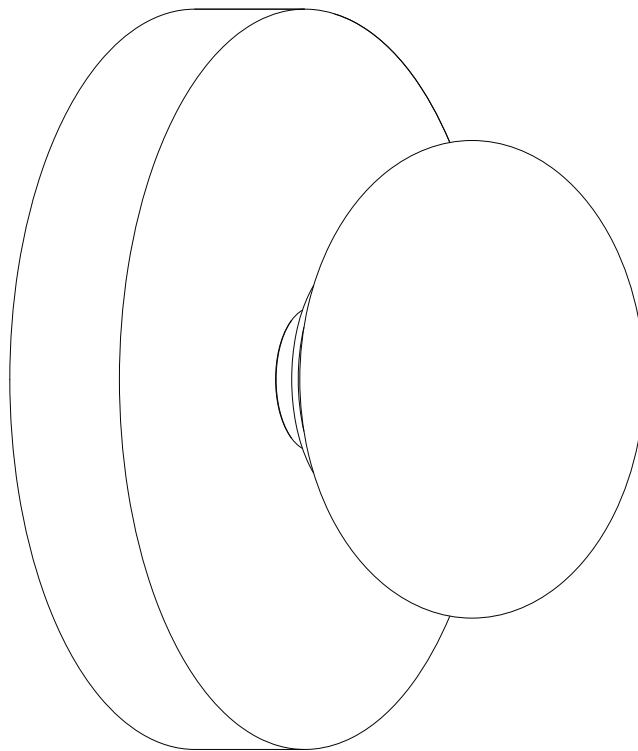

DOT 1x SCONCE

Installation Instructions





DOT 1x SCONCE

Congratulations on your purchase of a SkLO Dot 1x Sconce. This product must be installed in accordance with the applicable codes by a person familiar with the construction and operation of the product and the hazards involved, preferably a licensed electrician. Use a maximum 7W bulb.

When unpacking individual items and parts of the light fixture, make sure to lay them out on a protective surface that will neither mar the delicate metal finishes nor scratch the glass. Gloves (nitrile) are provided and must be worn during installation to avoid fingerprints on the finish of the exposed metal parts.

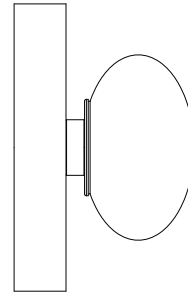

FOR WALL MOUNT ONLY

Your SkLO fixture will arrive with the hand-blown glass elements packed separately from the light fixture itself.

CONTENTS:

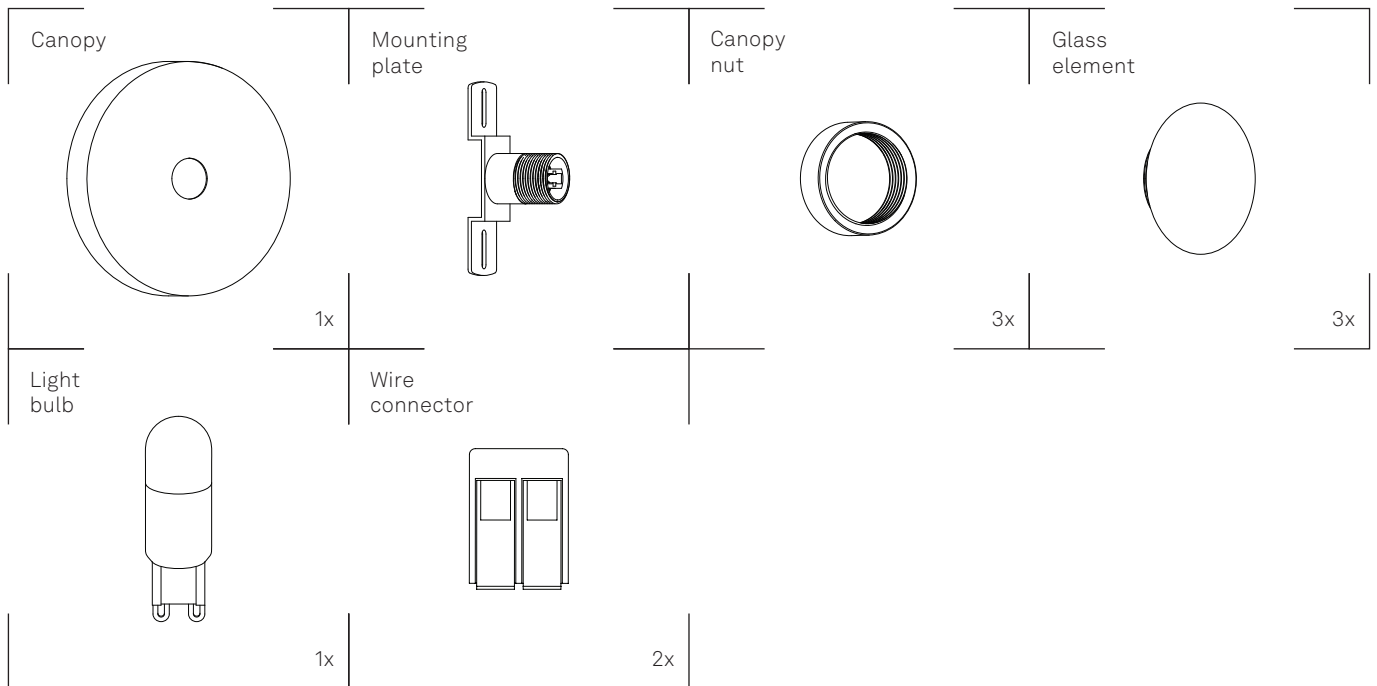



1. Install the mounting plate directly to recessed electrical box with the 8/32 thread screws (not provided) so that the 8/32 threaded holes spaced 2 3/4" on-center on the crossbar are leveled horizontally (Figure 1).
2. Connect the exposed leads of the fixture to the exposed leads on the wall following the wiring diagram and using the provided wire connectors. Attach the phase 1 (L1) to phase 1 (L1) of the light fixture, neutral (N) to neutral (N) of the light fixture (Figure 2). Please note the number and type of wire connectors may vary.
3. Carefully slide the canopy over the lampholder cups. Take care that no electrical cables or connections are exposed where the canopy meets the wall. Fasten the canopy by screwing the canopy nut onto the lampholder cup, making sure that the canopy sits flush against the wall finish surface (Figure 3). Take great care when installing canopy nuts so that they do not slip and scratch the canopy finish.
4. Install the supplied LED light bulb (20 W Max) into the sockets. This fixture uses a G9 socket and light bulb. The G9 is a bi-pin socket. Light bulb is to be inserted and removed by pushing

the bulb straight into the socket, and by pulling it straight out. The bulb, when inserted, should have a tight fit. Do not force the bulb. If there is resistance, check to make sure nothing inside the socket is bent or obstructing the bulb. Always turn off the power to the fixture when changing the bulb(s). Unwrap and lay out glass diffusers. Carefully thread a glass diffuser onto each socket (Figure 4). Thread on the glass diffusers just until they are visually tight – do not over tighten.

1.

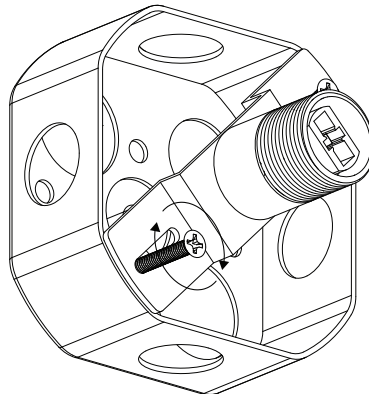

2.

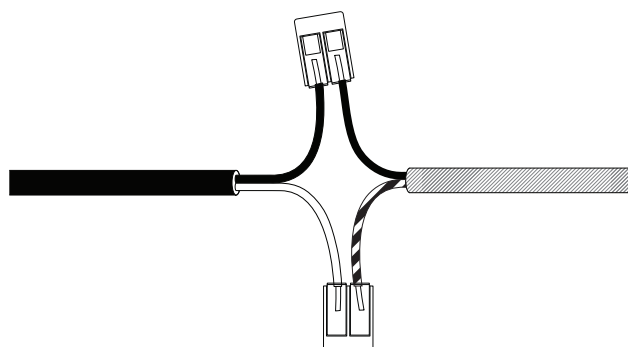



3.

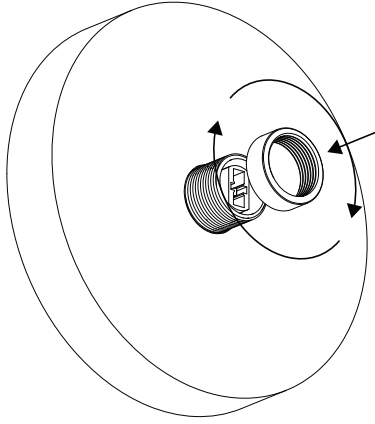

4.

