

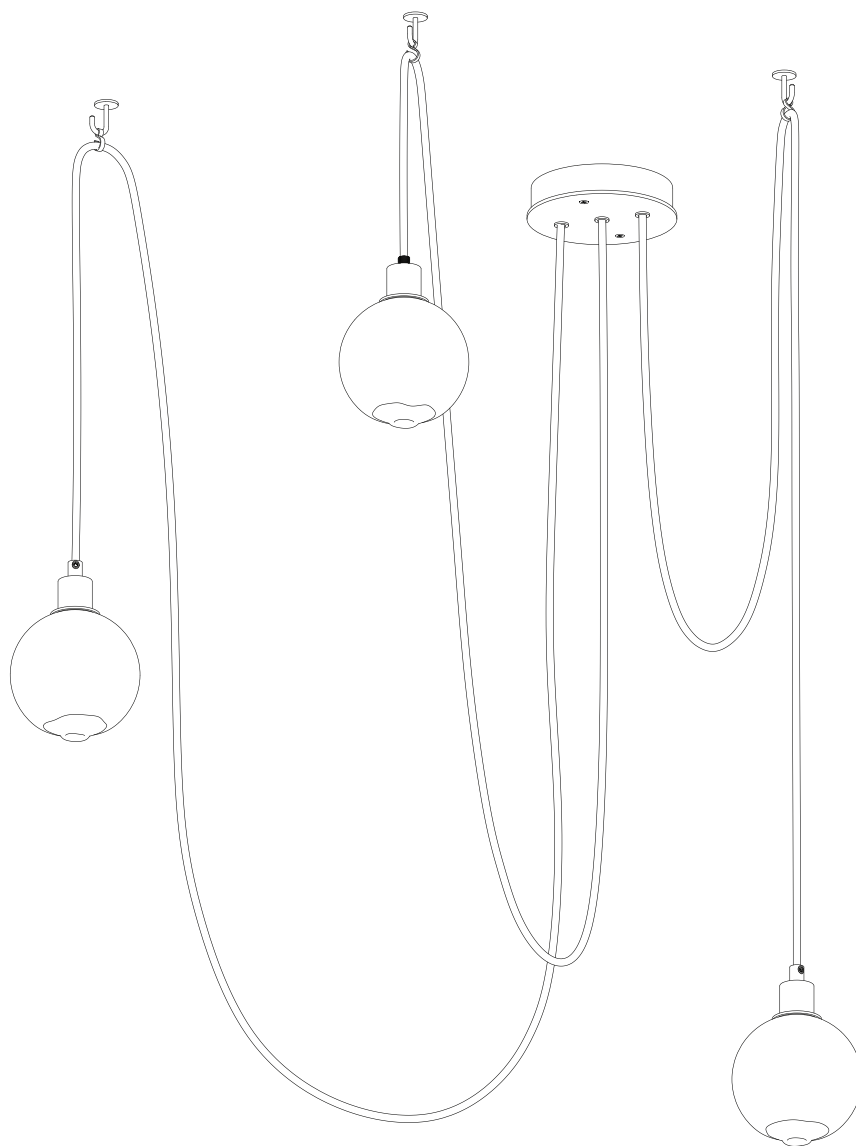

DRAPE HOOK 3 PENDANT

Installation Instructions



SkLO

sklo.com

SkLO US 115 WEST NORTH STREET HEALDSBURG CALIFORNIA 95448 USA +1.707.385.2101 us@sklo.com
SkLO EU VÁŽNÍ 488 500 03 HRADEC KRÁLOVÉ CZECH REPUBLIC +420.495.542.071 eu@sklo.com



DRAPE HOOK 3 PENDANT



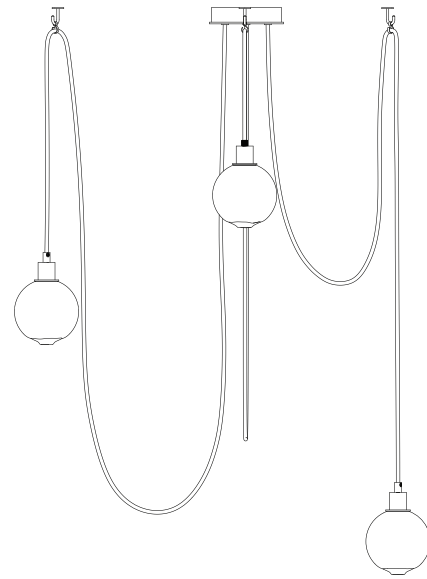

Congratulations on your purchase of a SkLO Drape Hook 3 Pendant. This product must be installed in accordance with the applicable codes by a person familiar with the construction and operation of the product and the hazards involved, preferably a licensed electrician. Use a maximum 7W bulb.

When unpacking individual items and parts of the light fixture, make sure to lay them out on a protective surface that will neither mar the delicate metal finishes nor scratch the glass. Gloves (nitrile) are provided and must be worn during installation to avoid fingerprints on the finish of the exposed metal parts.

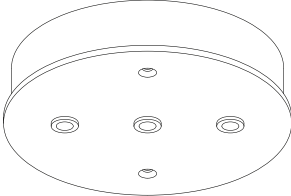
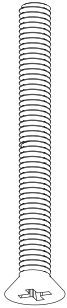
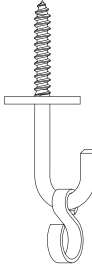

Your SkLO fixture will arrive with the hand-blown glass elements packed separately from the light fixture itself.

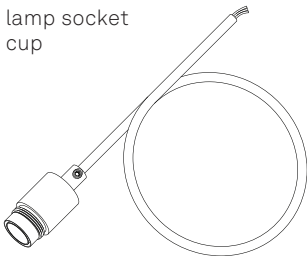
CONTENTS:

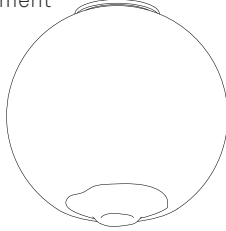
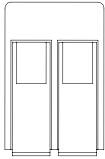
Canopy 	Machine screw 	Hook + "S" loop 	Strain relief 	
Cord + lamp socket cup 	Light bulb 	Glass element 	Wire connector 	
1x	3x	2x	3x	3x



1. Uncoil and gently smooth the fabric-wrapped electrical cords of each pendant. Determine the desired length of each cord and trim each one, making sure to leave enough additional length to make the wiring connections within the canopy. When trimming the fabric-wrapped electrical cords make sure to use electrical tape or other means to secure the fabric at the location of the cut, and then at the cut end to avoid splaying, fraying, or slack in the fabric.

Slide the provided brass “S” loops onto each cord (Figure 1).
2. Pass the fabric-wrapped electrical cords through the holes in the canopy (Figure 2).
3. Slide the provided plastic strain reliefs over the ends of cords and fix the length of cords by tightening the set screws – do not overtighten or damage the electrical cords and insulation (Figure 3).
4. This fixture requires an electrical box with available holes at 3 1/2” on center spacing. If a box with differently spaced threaded holes is present, additional parts may be required to install the fixture properly, such as a universal cross bar (not supplied).
5. Carefully supporting the fixture, connect the exposed leads of the fixture to the exposed leads in the electrical box, following the wiring diagram and using the provided wire connectors. Attach the ground (TE) wires to ground (TE) wires of the light fixture, phase 1 (L1) to phase 1 (L1) of the light fixture, neutral (N) to neutral (N) of the light fixture (Figure 4). Please note the number and type of wire connectors may vary.
6. Raise the canopy all the way flush to the ceiling, taking care that no electrical cables or connections are exposed where the canopy meets the ceiling. Install light by fastening the two supplied 8/32 thread brass machine screws directly into the appropriate holes in the electrical box through the holes provided in the canopy (Figure 5). Take great care when installing screws so that tools do not slip and scratch the canopy finish, or damage the exposed screw head slots.
7. Determine the composition for your Drape Hook 3, and install the brass hooks for each swagged pendant into the ceiling at the desired locations. Use anchors (not provided) appropriate to the ceiling material. Carefully slide the brass loop along the fabric-wrapped electrical cord taking great care not to tear or mar the fabric. Use needlenose pliers with taped jaws to slightly crimp the loop to fix the loop slightly into place. Hang the cord on the hook by slipping the open loop over the end of the hook (Figure 6).
8. Unwrap the protective packaging from each of the 3 individual pendants. Install the supplied LED light bulbs (7W Max) into the sockets (Figure 7). This fixture uses G9 sockets and light bulbs. The G9 is a bi-pin socket. Light bulbs are to be inserted and removed by pushing the bulb straight into the socket, and by pulling it straight out. The bulb, when inserted, should have a tight fit. Do not force the bulb. If there is resistance, check to make sure nothing inside the socket is bent or obstructing the bulb. Always turn off the power to the fixture when changing the bulb(s). Unwrap and lay out all individual glass diffusers.
9. Carefully thread a glass diffuser onto each socket. Thread on the glass diffusers just until they are visually tight – do not overtighten.



1.

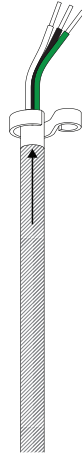

2.

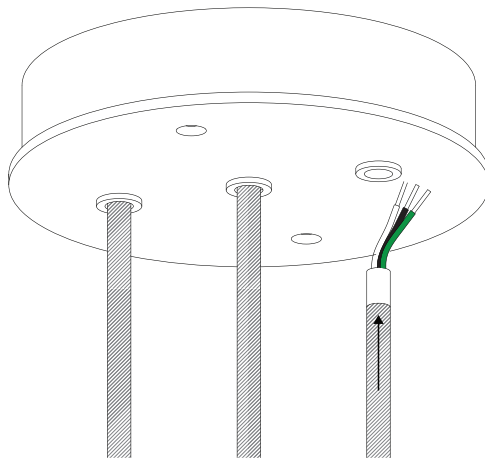

3.

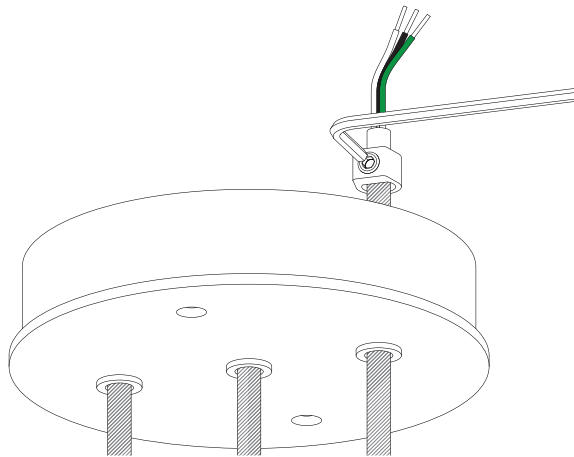

4.

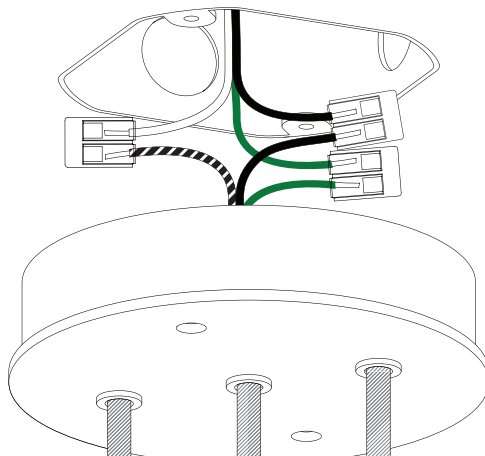



5.

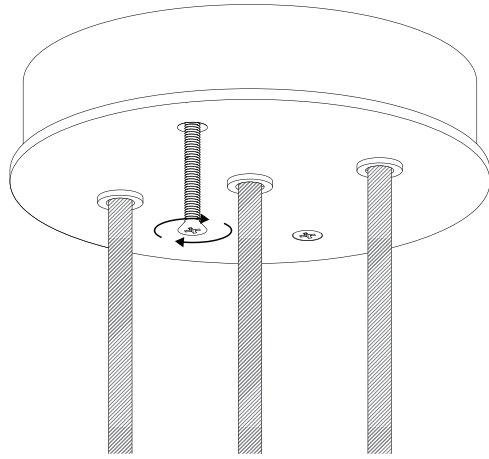

6.

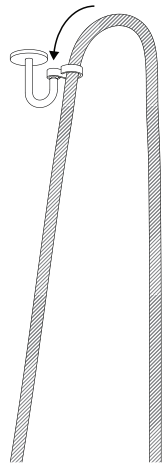
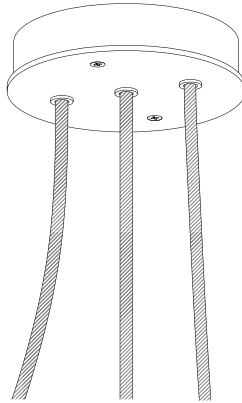
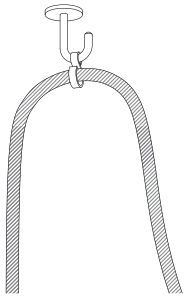

7.

