

SkLO

Drape Arm 1.09

SCONCE

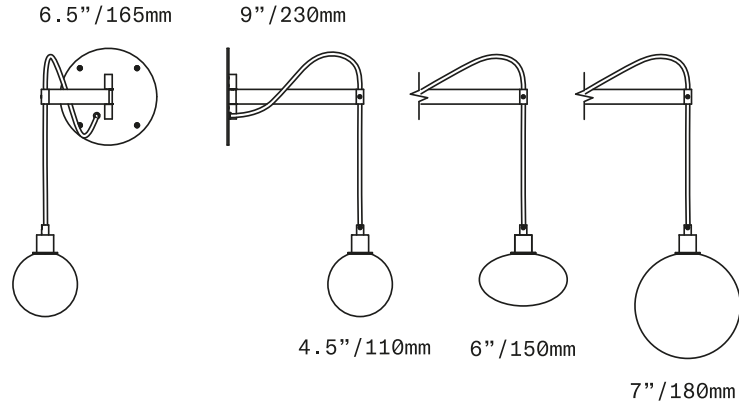

The Drape Arm 1.09 Sconce is a single diffuser of handblown Czech glass suspended from a moveable 9"/230mm arm. The glass diffusers are available in three shapes and in both "dipped" glass, featuring the SkLO double-dipped flame-polished mouth and "textured" glass, featuring a soft, frosted finish and subtle sculpted vertical ridges. They are suspended from the arm on a fabric-wrapped electrical cord. The exposed cord passes through the end of the arm and returns to the canopy at the wall. Solid brass construction throughout, the arm is hinged for a full 180-degree swing.

UL listed suitable for dry and damp locations (US & Canada)

Socket 120V G9 7W Max

LED bulb included

Requires recessed electrical box for installation

Field adjustable – Standard cord length 72"/1830mm – longer lengths available at additional cost

Fixture weights (approximate):
 4.5lbs/2.0kg (LT363)
 6.5lbs/3.0kg (LT364)
 4.5lbs/2.0kg (LT390)

All glass dimensions are approximate – handblown glass dimensions vary by nature and intent

Made in the Czech Republic

LT363 [---][--] 4.5"/110mm sphere glass
 LT364 [---][--] 7"/180mm sphere glass
 LT390 [---][--] 6"/150mm ellipsoid glass

Dipped Glass colors

- Clear [CLR]
- New Blue [NBL]
- Olivin [OLV]
- Smoke [SMK]
- White [WHT]

Textured Glass colors

- Clear [TCL]
- Neutral Gray [NGT]
- Steel Blue [TSB]
- Whiskey [TWS]

Metal finishes

- Dark Oxidized [DX]
- Brushed Brass [BB]
- Brushed Nickel [BN]
- Polished Nickel [PN]

Cord Colors

- Black
- Blue
- Gold
- Gray

