

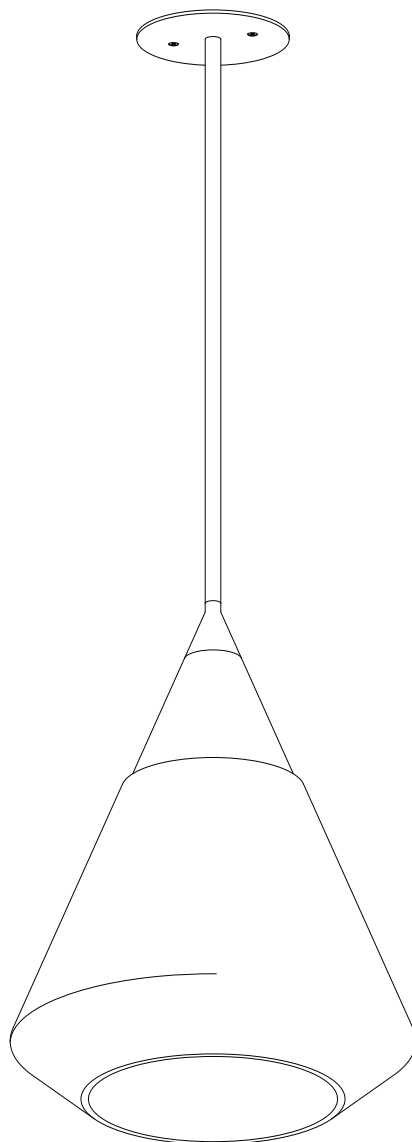

# REST PENDANT SHAPE 3

## Installation Instructions



**SkLO**

sklo.com

SkLO US 115 WEST NORTH STREET HEALDSBURG CALIFORNIA 95448 USA +1.707.385.2101 us@sklo.com  
SkLO EU VÁŽNÍ 488 500 03 HRADEC KRÁLOVÉ CZECH REPUBLIC +420.495.542.071 eu@sklo.com



## REST PENDANT SHAPE 3

*Congratulations on your purchase of a SkLO Rest Pendant. This product must be installed in accordance with the applicable codes by a person (two persons required) familiar with the construction and operation of the product and the hazards involved, preferably a licensed electrician. Use a maximum 60W bulb.*

**When unpacking individual items and parts of the light fixture, make sure to lay them out on a protective surface that will neither mar the delicate metal finishes nor scratch the glass. Gloves (nitrile) are provided and must be worn during installation to avoid fingerprints on the finish of the exposed metal parts.**

*Your SkLO fixture will arrive with the hand-blown glass elements packed separately from the light fixture itself.*

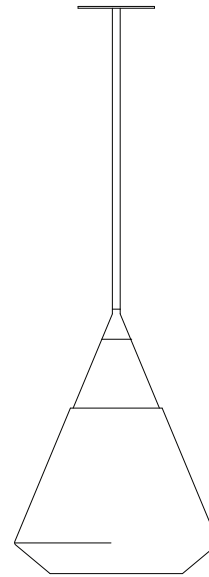

### CONTENTS:

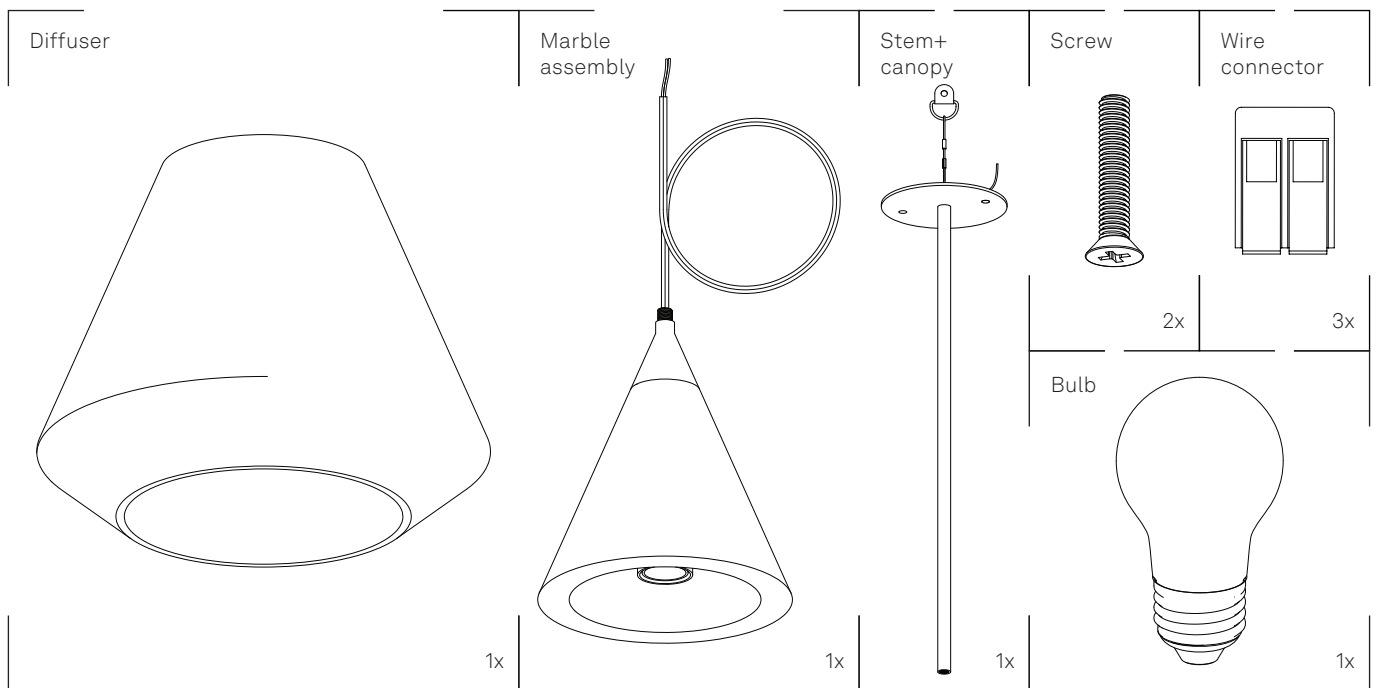



1. Feed the exposed wires at the top of the marble assembly through the stem/canopy with the female/internal thread facing down. Attach the stem to the fixture by threading it onto the exposed nipple at the top of the marble assembly. Place the assembly on a clean surface in a way that the marble sits on its flat surface (Figure 1).

For lights with longer OAD lengths, the stem will be in multiple parts. Uncoil the electrical wiring at the top of the fixture and carefully pass the wires through each stem as you fasten them together. To connect the stems, first, attach one of the lengths of the stem to the fixture by threading the open female/ internally threaded end of the stem onto the exposed threaded nipple on the top of the fixture (Figure 1). Then, attach the remaining stem lengths by threading the open end of each stem onto the exposed nipple of the other (Figure 2).

2. Carefully slide the glass diffuser onto the marble assembly, then position it on the same surface as the marble assembly to ensure both pieces are aligned. Handle the glass diffuser with care to avoid chipping or breaking, especially when moving it along the marble. Be cautious not to bump the marble (Figure 3).
3. This fixture comes with a secondary support cable. This cable is required by UL and must support the weight of the fixture, allowing it to be removed and inspected with wiring in place without hanging from the electrical wiring itself. The support cable will be attached to the loop/nut used to attach the canopy to the stem. Slowly and carefully raise the pendant assembly until the glass diffuser fully rests on the marble cone. Once the glass diffuser sits on marble, raise the pendant close to the ceiling so that the connections can be made. Using an appropriate fastener, fasten the loose end of the support cable through the side of the electrical box directly into a structural member through the hole provided in the ring as shown in the drawing (Figure 4).

4. Carefully supporting the fixture, connect the exposed leads of the fixture to the exposed leads in the electrical box, following the wiring diagram and using the provided wire connectors. Attach the ground (TE) wires to ground (TE) wires of the light fixture, phase 1 (L1) to phase 1 (L1) of the light fixture, neutral (N) to neutral (N) of the light fixture (Figure 5). Please note the number and type of wire connectors may vary.
5. This pendant requires an electrical box with available holes at 3 1/2" on center spacing. If a box with differently spaced threaded holes is present, additional parts may be required to install the fixture properly, such as a universal cross bar (not supplied). Install the canopy by fastening the two supplied 8/32 thread brass machine screws directly into the appropriate holes in the electrical box through the holes and guides provided as part of the canopy, making sure that the canopy sits flat and flush against the finish surface (Figure 6). Take great care when installing screws so that tools do not slip and scratch the canopy finish, or damage the exposed screw head slots.
6. Install the supplied LED light bulb (60W Max) into the socket (Figure 7).



1.

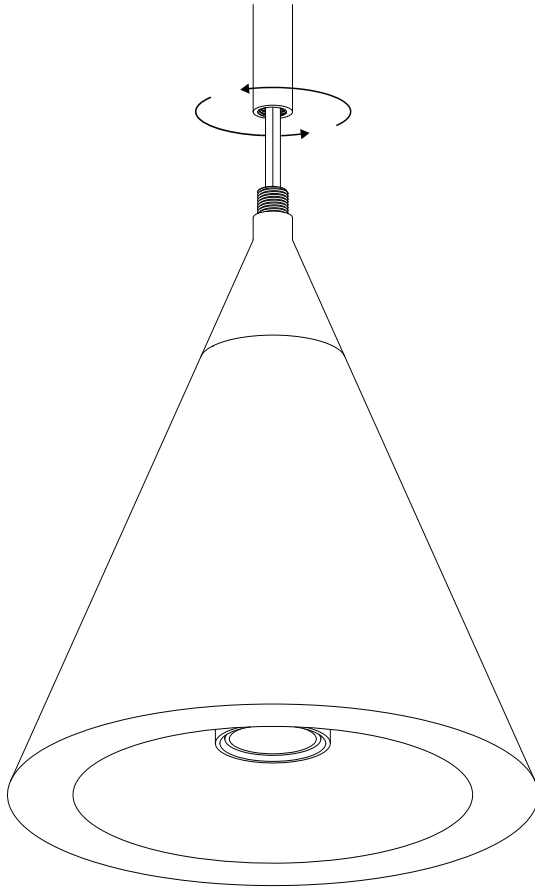

2.

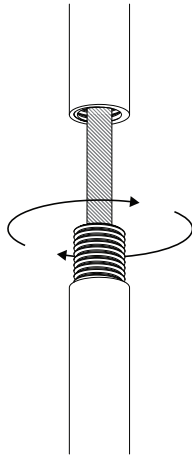



3.

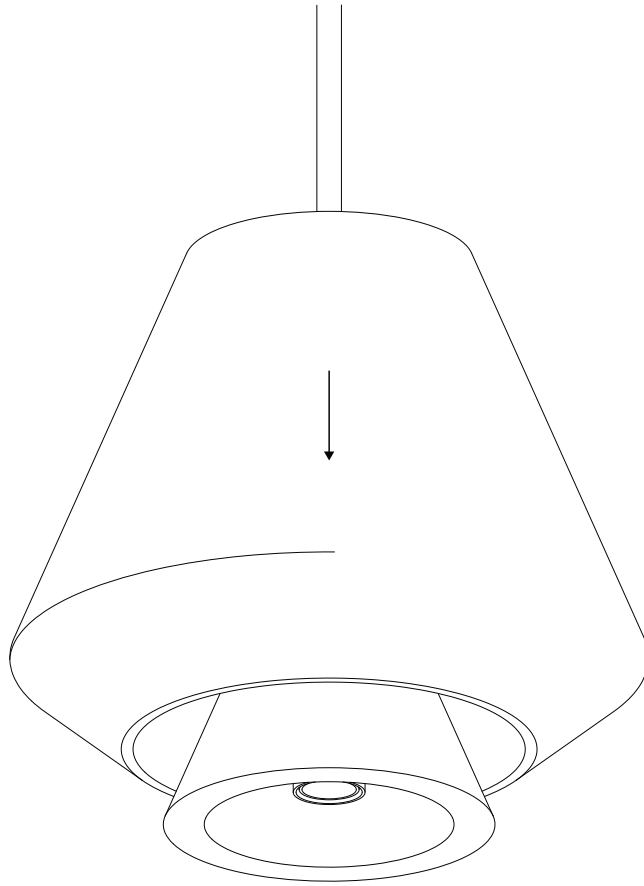

4.

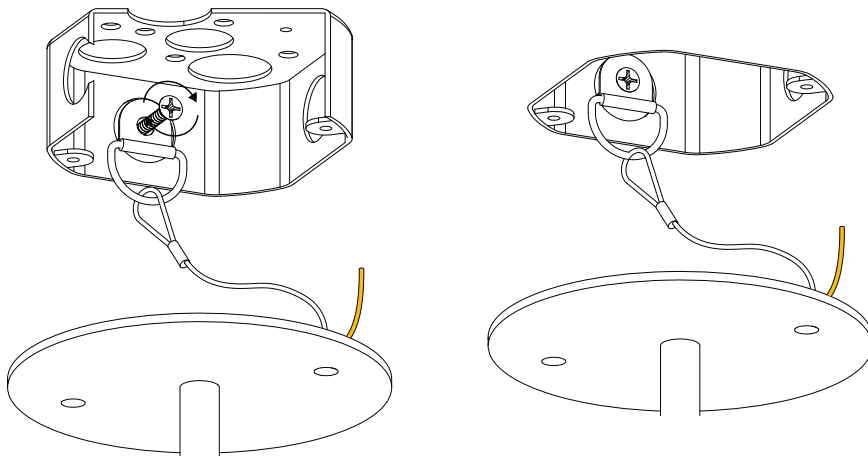

5.

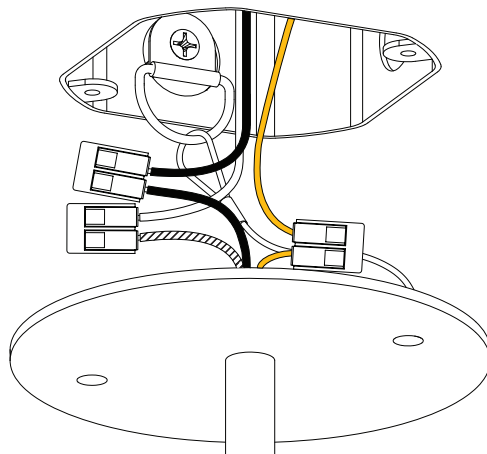



6.

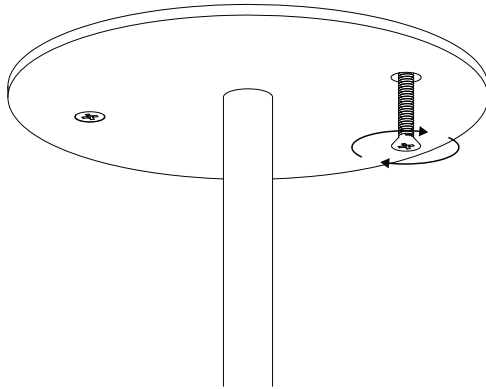

7.

