



SKLO : LIT

balance *pendant*



balance pendant shown with opaque white glass and brushed brass metal finish

balance pendant

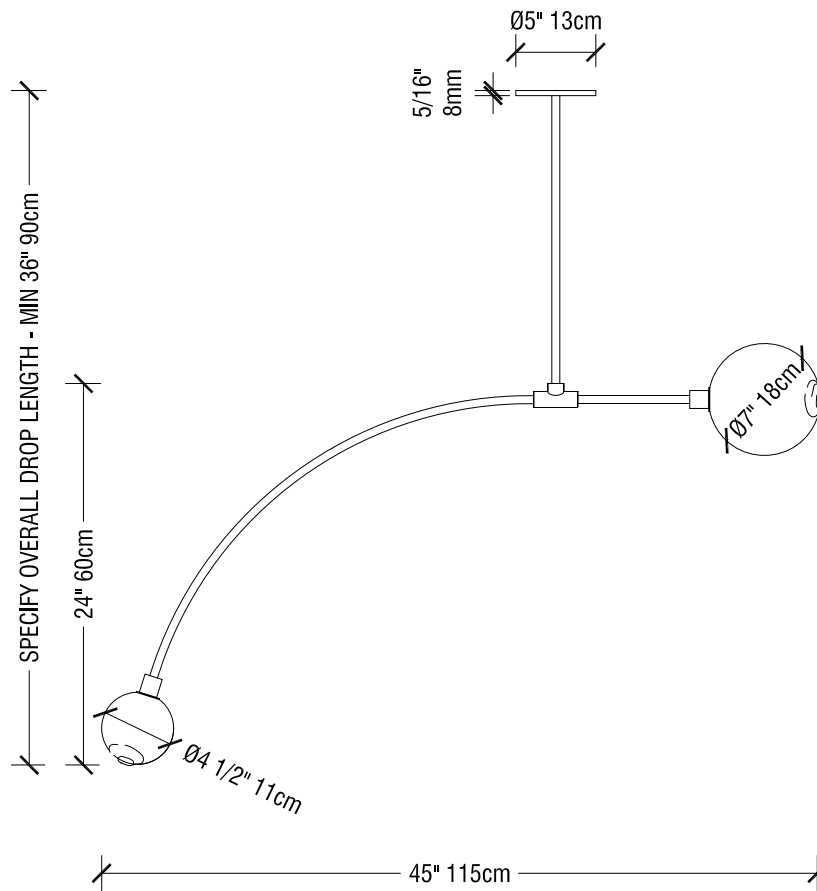

The *balance* pendant is a minimal, sculptural suspended light composed of a larger lit 7" (18cm) diameter sphere on a short horizontal stem balanced by a smaller lit 4 1/2" (11cm) diameter sphere on a longer, downward arcing stem. The spherical glass diffusers feature the signature SkLO double-dipped, fire-polished mouths which show where the glass is broken from the blower's pipe, making each unique.

UL LISTED SUITABLE FOR DAMP LOCATIONS (US & CANADA)

Sockets: 120V E12 (candelabra) 7W Max (G9 sockets available on request)

Canopy: Brass canopy with exposed fasteners. Recessed steel electrical box required for installation

Pendant suspended from canopy on rigid brass stem (not field adjustable)

Specify overall drop length

Minimum overall drop length is 36" (90cm). Lengths over 60" (152cm) available at additional cost

Bulbs included

Standard metal finishes: dark oxidized / brushed brass (other finishes available on request)

Five glass colors available (including clear)

All glass dimensions are approximate – handblown glass dimensions vary by nature and intent

Handblown in the Czech Republic

transparent colors:



clear-CLR



olivin-OLV



smoke-SMK

opaque colors:



new blue-NBL



white-WHT

LT500 --- **balance** pendant dark oxidized

LT500 --- B **balance** pendant brushed brass

45"L (115cm)

45"L (115cm)

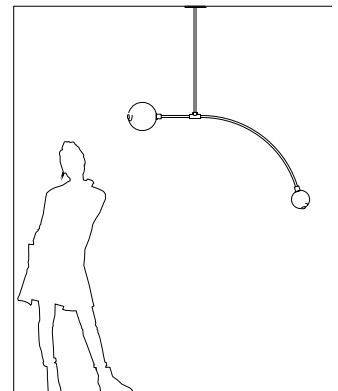

bell jar *light*



small bell jar light shown with clear glass and brushed brass metal finish

bell jar light

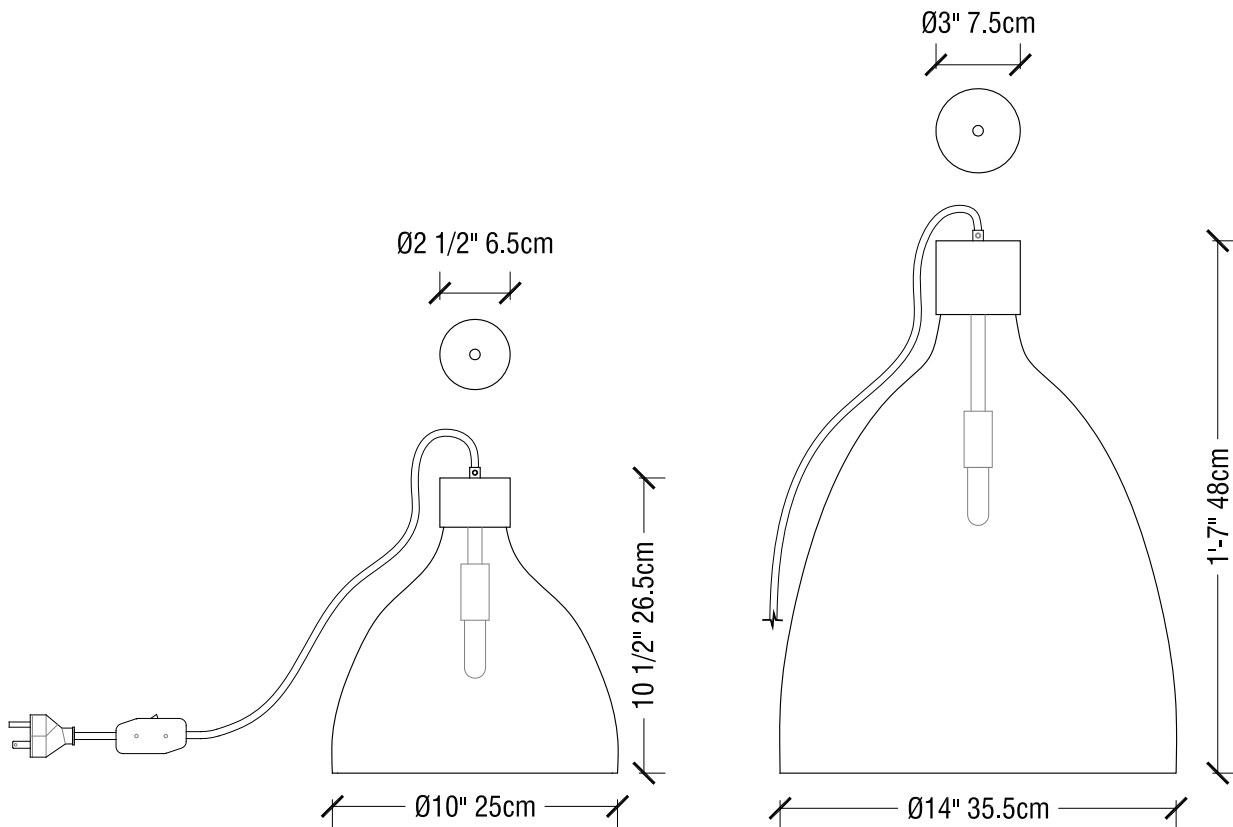

Handblown glass "bell" shapes act as the diffuser for a single bulb suspended within. A solid brass cap sits atop the neck, the socket hangs from the cap on a short rigid brass stem. Available in two sizes and two glass colors: Clear, and transparent Olivin.

Socket: 120V E12 (candelabra) 7W Max
 6ft (180cm) black fabric-wrapped cord with in-line switch
 Bulb included

Standard metal finishes: dark oxidized / brushed brass (other finishes available on request)
 Two glass colors available (including clear)
 All glass dimensions are approximate – handblown glass dimensions vary by nature and intent
 Handblown in the Czech Republic

glass colors: CLR-clear OLV-olivin

- LT355 --- bell jar light small dark oxidized
- LT355 --- B bell jar light small brushed brass
- LT356 --- bell jar light tall dark oxidized
- LT356 --- B bell jar light tall brushed brass

- 10.5"H x 10"Dia (26.5x25cm)
- 10.5"H x 10"Dia (26.5x25cm)
- 1'-7"H x 14"Dia (48x35.5cm)
- 1'-7"H x 14"Dia (48x35.5cm)

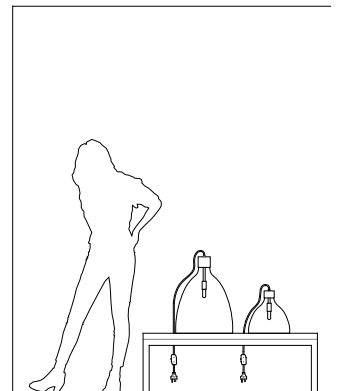

dew pendant



dew pendants shown with brushed brass metal finish

dew pendant

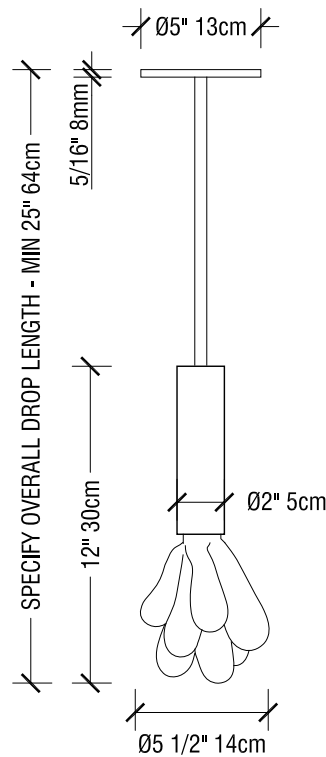

The *dew* pendant is an intense expression of the molten nature of handblown glass. For a diffuser, the *dew* pendant features a solid sculpted glass shape composed of layers of glass applied while hot, giving it a "dripping" appearance. The glass is permanently attached to the solid brass armature, which is hidden behind a brass cylinder. The light bulb is changed by simply lifting the brass cylinder upwards to access the socket. Note that the fixture also "uplights" slightly through the open top of the cylinder. The glass diffuser element is available in either clear glass or sandblasted glass, for two very different effects.

German Design Award Winner 2020 – Excellent Product Design

UL LISTED SUITABLE FOR DAMP LOCATIONS (US & CANADA)

Socket: 120V E12 (candelabra) 7W Max (G9 socket available on request)

Canopy: Brass canopy with exposed fasteners. Recessed steel electrical box required for installation

Pendant suspended from canopy on rigid brass stem (not field adjustable)

Specify overall drop length

Minimum overall drop length is 25" (64cm). Lengths over 50" (127cm) available at additional cost

Bulb included

Standard metal finishes: dark oxidized / brushed brass (other finishes available on request)

Two glass colors available (including clear)

All glass dimensions are approximate – handblown glass dimensions vary by nature and intent

Handblown in the Czech Republic

glass colors: clear-CLR sandblasted-SBT

LT410 --- dew pendant dark oxidized

5.5"Dia (14cm)

LT410 --- B dew pendant brushed brass

5.5"Dia (14cm)

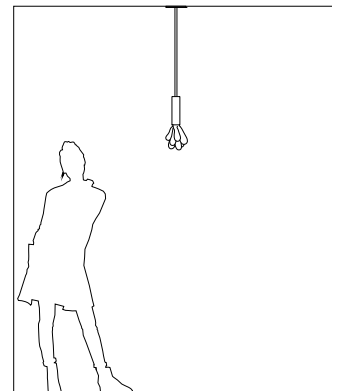

dew scone



dew scone shown with sandblasted glass and dark oxidized metal finish

dew sconce

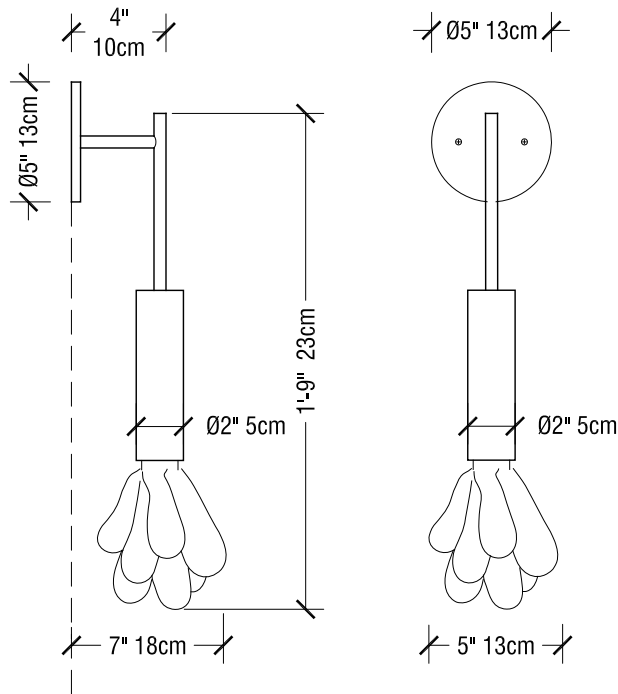

The *dew sconce* is an intense expression of the molten nature of handblown glass. For a diffuser, the *dew sconce* features a solid sculpted glass shape composed of layers of glass applied while hot, giving it a "dripping" appearance. The glass is permanently attached to the solid brass armature, which is hidden behind a brass cylinder. The light bulb is changed by simply lifting the brass cylinder upwards to access the socket. Note that the fixture also "uplights" slightly through the open top of the cylinder. The glass diffuser element is available in either clear glass or sandblasted glass, for two very different effects.

UL LISTED SUITABLE FOR DAMP LOCATIONS (US & CANADA)

Socket: 120V E12 (candelabra) 7W Max (G9 socket available on request)

Canopy: Brass canopy with exposed fasteners. Recessed steel electrical box required for installation

Bulb included

Standard metal finishes: dark oxidized / brushed brass (other finishes available on request)

Two glass colors available (including clear)

All glass dimensions are approximate – handblown glass dimensions vary by nature and intent

Handblown in the Czech Republic

glass colors: clear-CLR sandblasted-SBT

LT412 --- dew sconce dark oxidized

1'-9"H x 7"D (23x18cm)

LT412 --- B dew sconce brushed brass

1'-9"H x 7"D (23x18cm)

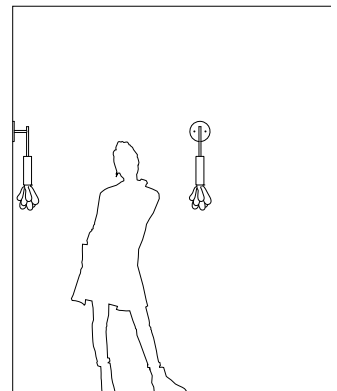

drape *pendant*



drape pendant shown with 18cm smoke glass, dark oxidized metal finish and black fabric-wrapped cord

drape pendant

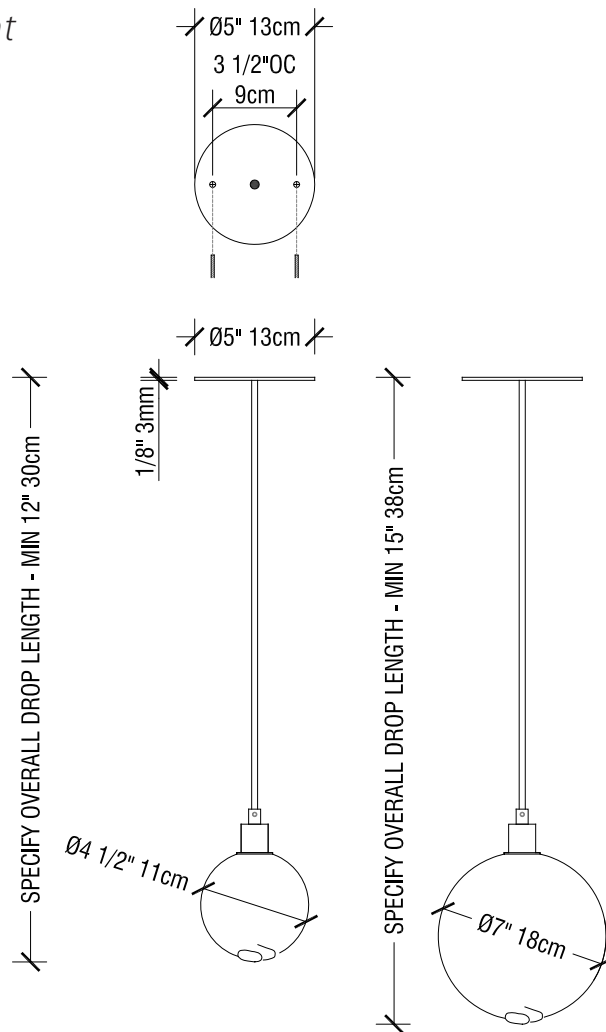

The *drape* pendant is a minimal pendant consisting of a single lit sphere of handblown Czech glass suspended on a fabric-wrapped electrical cord. Choose from either a small, 4 1/2" (11cm) or a large, 7" (18cm) diameter sphere, both available in five glass colors. The spherical glass diffusers feature the signature SkLO double-dipped, fire-polished mouths which show where the glass is broken from the blower's pipe, making each unique.

UL LISTED SUITABLE FOR DAMP LOCATIONS (US & CANADA)

Socket – 120V E12 (candelabra) 7W Max (G9 socket available on request)

Canopy: Brass canopy with exposed fasteners. Recessed steel electrical box required for installation

Pendant suspended from canopy on fabric-wrapped electrical cord (field adjustable on request)

Specify overall drop length

Minimum overall drop length is 12"/30cm (LT160) and 15"/38cm (LT161). Lengths over 42"/107cm (LT160) and 45"/115cm (LT161) available at additional cost

Specify fabric-wrapped electrical cord color: black, blue, gold, or gray

Bulb included

Standard metal finishes: dark oxidized / brushed brass (other finishes available on request)

Five glass colors available (including clear)

Four fabric-wrapped electrical cord colors available

All glass dimensions are approximate – handblown glass dimensions vary by nature and intent

Handblown in the Czech Republic

transparent colors:



clear-CLR



olivin-OLV



smoke-SMK

opaque colors:



new blue-NBL



white-WHT

LT160 ---	drape pendant dark oxidized	4.5"Dia (11cm) glass
LT160 --- B	drape pendant brushed brass	4.5"Dia (11cm) glass
LT161 ---	drape pendant dark oxidized	7"Dia (18cm) glass
LT161 --- B	drape pendant brushed brass	7"Dia (18cm) glass

cord colors available

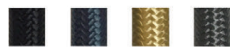

black blue gold gray

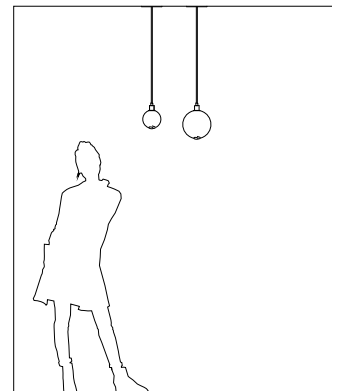

drape arm 1 *sconce*



*top: drape arm 1 sconce shown with long arm, 4 1/2" smoke glass and brushed brass metal finish
bottom: drape arm 1 sconce shown with short arm, 4 1/2" opaque white glass and dark oxidized metal finish*

drape arm 1 *sconce*

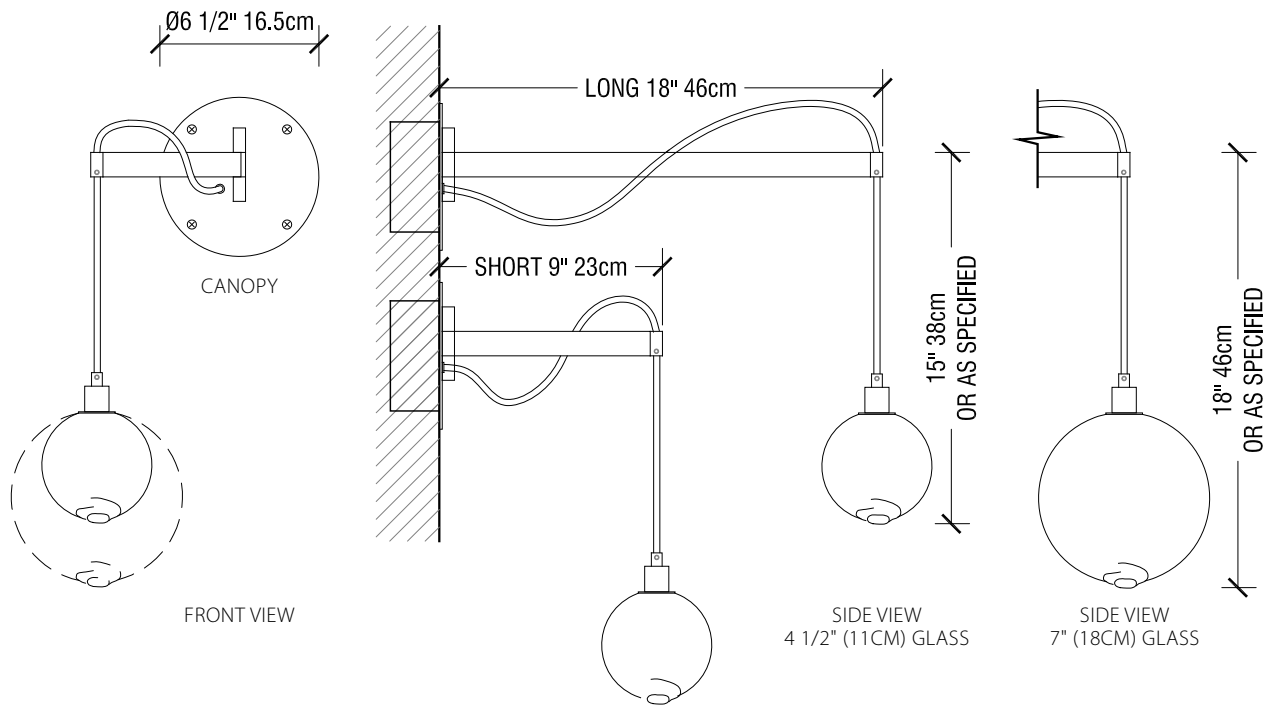

The *drape arm 1* sconce consists of a single lit sphere of handblown Czech glass suspended from a moveable arm. The sphere is either 4 1/2" (11 cm) or 7" (18 cm) diameter and is suspended from the arm on a fabric-wrapped electrical cord. The exposed cord passes through the end of the arm and returns to the canopy at the wall. Solid brass construction throughout, the arm is hinged for a full 180-degree horizontal swing and is available in two lengths. The spherical glass diffusers feature the signature SKLO double-dipped, fire-polished mouths which show where the glass is broken from the blower's pipe, making each unique.

UL LISTED SUITABLE FOR DAMP LOCATIONS (US & CANADA)

Socket: 120V E12 (candelabra) 7W Max (G9 socket available on request)

Canopy: Brass canopy with exposed fasteners and steel mounting plate. Recessed electrical box required for installation

Specify fabric-wrapped electrical cord color: black, blue, gold, or gray

Bulb included

Standard metal finishes: dark oxidized / brushed brass (other finishes available on request)

Five glass colors available (including clear)

Two glass sizes available: 4 1/2" (11 cm) or 7" (18 cm) diameter

Two arm lengths available: Long 18" (46 cm) or Short 9" (23 cm)

Four fabric-wrapped electrical cord colors available

All glass dimensions are approximate – handblown glass dimensions vary by nature and intent

Handblown in the Czech Republic

transparent colors:



clear-CLR



olivin-OLV



smoke-SMK

opaque colors:



new blue-NBL



white-WHT

LT361 ---	drape arm 1	<i>sconce</i>	dark oxidized	4.5"Dia (11 cm) glass	long arm	15"H x 18"L (38x46cm)
LT361 --- B	drape arm 1	<i>sconce</i>	brushed brass	4.5"Dia (11 cm) glass	long arm	15"H x 18"L (38x46cm)
LT362 ---	drape arm 1	<i>sconce</i>	dark oxidized	7"Dia (18 cm) glass	long arm	18"H x 18"L (46x46cm)
LT362 --- B	drape arm 1	<i>sconce</i>	brushed brass	7"Dia (18 cm) glass	long arm	18"H x 18"L (46x46cm)
LT363 ---	drape arm 1	<i>sconce</i>	dark oxidized	4.5"Dia (11 cm) glass	short arm	15"H x 9"L (38x23cm)
LT363 --- B	drape arm 1	<i>sconce</i>	brushed brass	4.5"Dia (11 cm) glass	short arm	15"H x 9"L (38x23cm)
LT364 ---	drape arm 1	<i>sconce</i>	dark oxidized	7"Dia (18 cm) glass	short arm	18"H x 9"L (46x23cm)
LT364 --- B	drape arm 1	<i>sconce</i>	dark oxidized	7"Dia (18 cm) glass	short arm	18"H x 9"L (46x23cm)

cord colors available



black blue gold gray

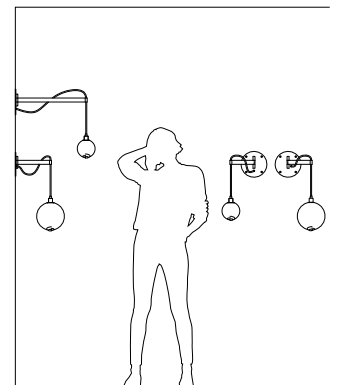

drape arm 3 *pendant*



drape arm 3 pendant shown with opaque white glass, brushed brass metal finish and black fabric-wrapped cord

drape arm 3 pendant

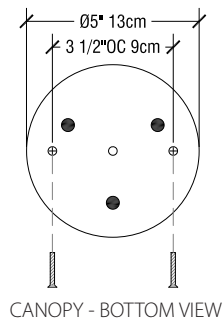
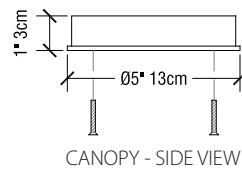
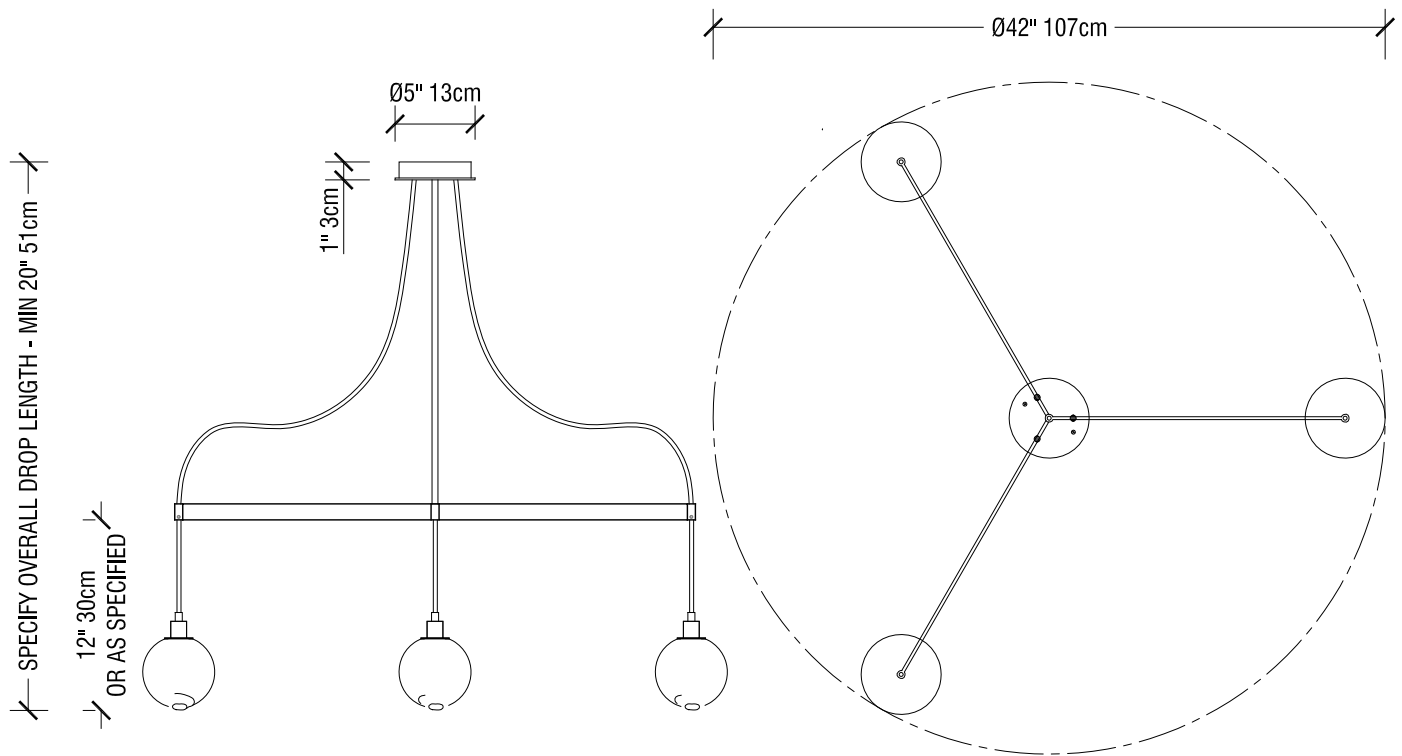

The *drape arm 3* pendant consists of 3 individual pendants hung from a 3-arm brass structure suspended from a single canopy. Each individual pendant is a 4 1/2" (11 cm) diameter sphere of handblown Czech glass suspended on a fabric-wrapped electrical cord. The exposed cords issue from the canopy and pass through the individual arms. The spherical glass diffusers feature the signature SkLO double-dipped, fire-polished mouths which show where the glass is broken from the blower's pipe, making each unique.

UL LISTED SUITABLE FOR DAMP LOCATIONS (US & CANADA)
 Sockets: 120V E12 (candelabra) 7W Max (G9 sockets available on request)
 Canopy: Brass canopy with exposed fasteners. Recessed steel electrical box required for installation
 Specify overall drop length – see drawing for additional required specification
 Minimum overall drop length is 20" (51cm). Lengths over 50" (127cm) available at additional cost
 Specify fabric-wrapped electrical cord color: black, blue, gold, or gray
 Bulbs included

Standard metal finishes: dark oxidized / brushed brass (other finishes available on request)
 Five glass colors available (including clear)
 Four fabric-wrapped electrical cord colors available
 All glass dimensions are approximate – handblown glass dimensions vary by nature and intent
 Handblown in the Czech Republic

transparent colors:



clear-CLR

olivin-OLV

smoke-SMK

opaque colors:



new blue-NBL

white-WHT

LT360 --- drape arm 3 pendant dark oxidized
 LT360 --- B drape arm 3 pendant brushed brass

42" Dia (107cm)
 42" Dia (107cm)

cord colors available



black blue gold gray

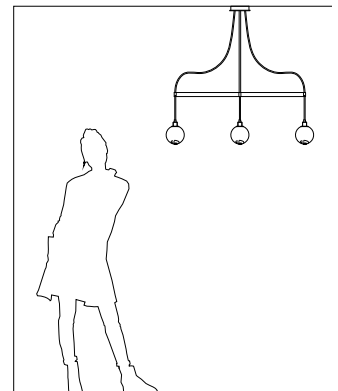

drape circle 8 *chandelier*



drape circle 8 chandelier shown with transparent smoke glass, dark oxidized metal finish and black fabric-wrapped cord

drape circle 8 chandelier

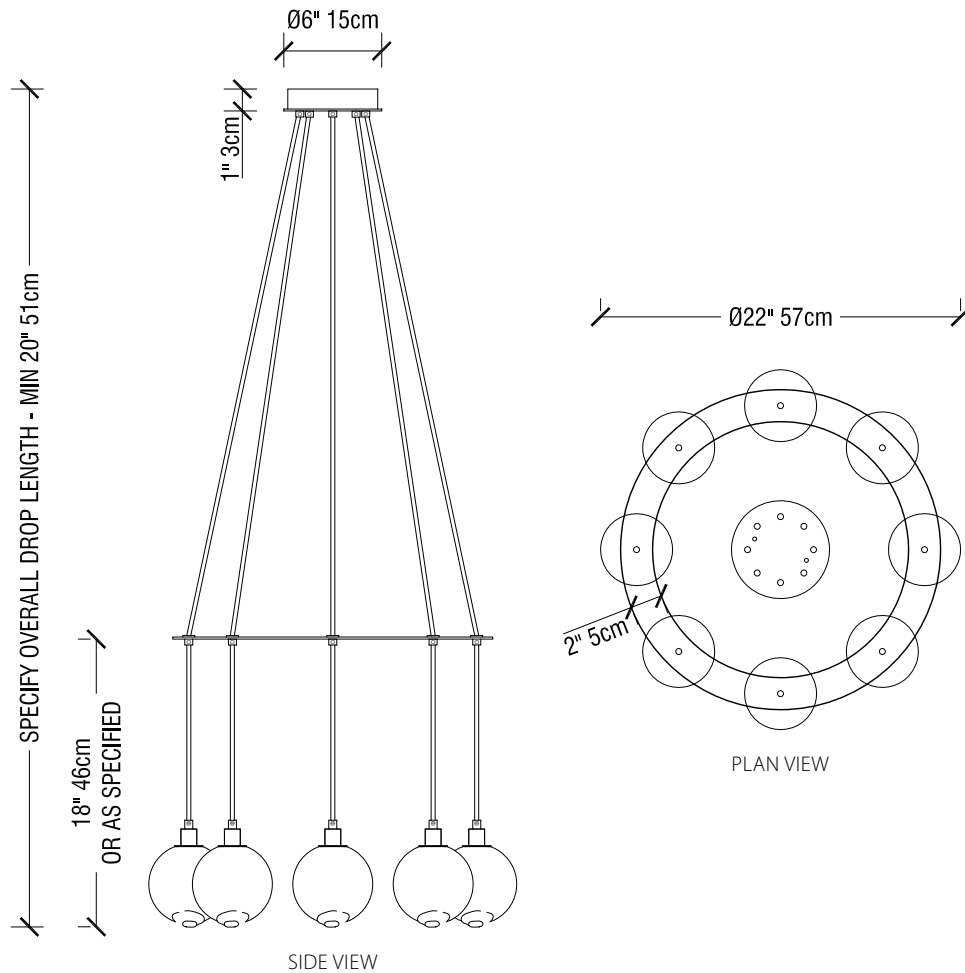

The *drape circle 8* chandelier consists of 8 individual pendants gathered and supported by a brass ring. Each pendant features a 4 1/2" (11 cm) diameter sphere of handblown Czech glass suspended on a fabric-wrapped electrical cord. The cords pass through the ring and are evenly spaced around the circumference. The spherical glass diffusers feature the signature SkLO double-dipped, fire-polished mouths which show where the glass is broken from the blower's pipe, making each unique.

UL LISTED SUITABLE FOR DAMP LOCATIONS (US & CANADA)

Sockets: 120V E12 (candelabra) 7W Max (G9 sockets available on request)

Canopy: Brass canopy with exposed fasteners and steel mounting plate. Recessed electrical box required for installation

Specify overall drop length – see drawing for additional required specification

Minimum overall drop length is 20" (52cm). Lengths over 96" (245cm) available at additional cost

Specify fabric-wrapped electrical cord color: black, blue, gold, or gray

Bulbs included

Standard metal finishes: dark oxidized / brushed brass (other finishes available on request)

Five glass colors available (including clear)

Four fabric-wrapped electrical cord colors available

All glass dimensions are approximate – handblown glass dimensions vary by nature and intent

Handblown in the Czech Republic

transparent colors:



clear-CLR



olivin-OLV



smoke-SMK

opaque colors:



new blue-NBL



white-WHT

LT280 --- drape circle 8 chandelier dark oxidized

22"Dia (57cm)

LT280 --- B drape circle 8 chandelier brushed brass

22"Dia (57cm)

cord colors available



black blue gold gray

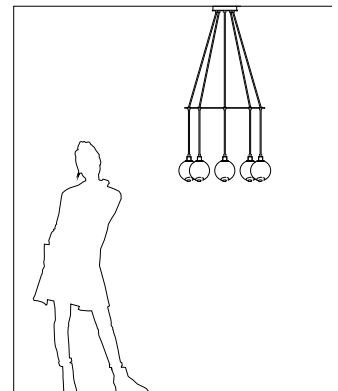

drape circle 12 *chandelier*



drape circle 12 chandelier shown with 4 1/2" opaque white glass, brushed brass metal finish and gold fabric-wrapped cord

drape circle 12 chandelier

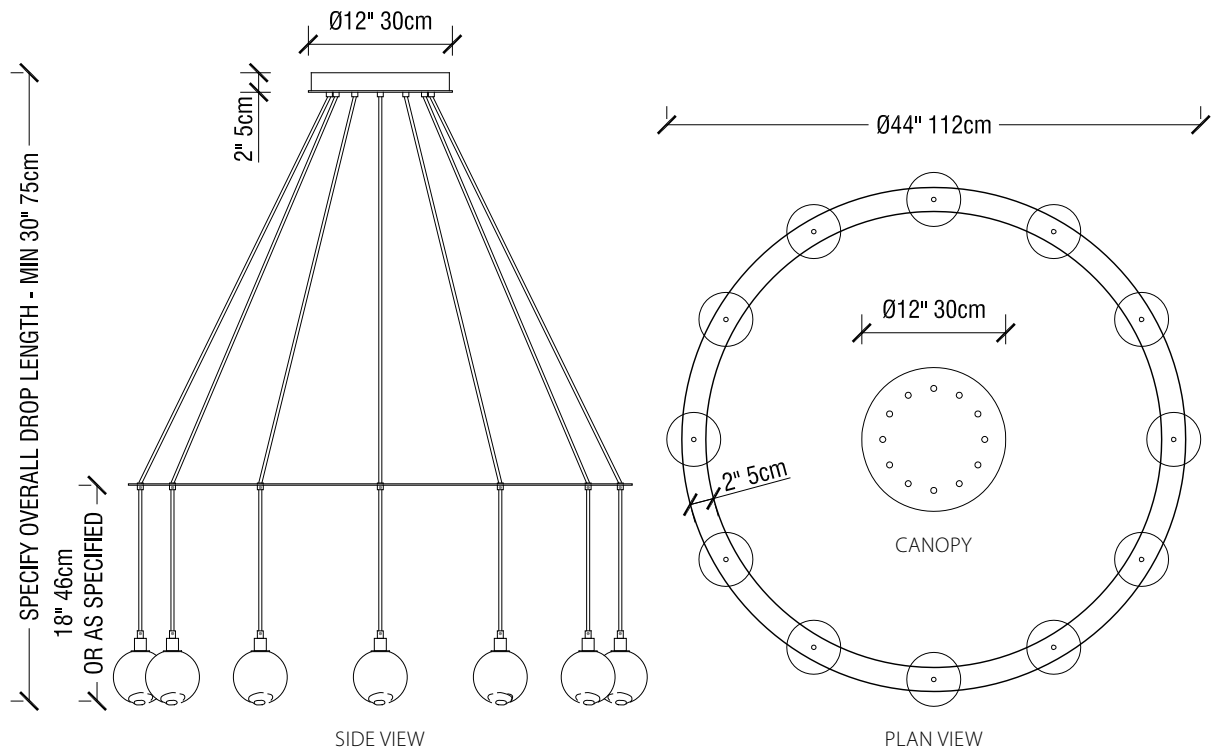

The *drape circle 12* chandelier consists of 12 individual pendants gathered and supported by a single, large brass ring. Each pendant features either 4 1/2" (11cm) or 7" (18cm) diameter sphere of handblown Czech glass suspended on a fabric-wrapped electrical cord. The cords pass through and support the ring. The spherical glass diffusers feature the signature SkLO double-dipped, fire-polished mouths which show where the glass is broken from the blower's pipe, making each unique.

UL LISTED SUITABLE FOR DAMP LOCATIONS (US & CANADA)

Sockets: 120V E12 (candelabra) 7W Max (G9 sockets available on request)

Canopy: Brass canopy with exposed fasteners and steel mounting plate. Recessed electrical box required for installation

Specify overall drop length – see drawing for additional required specification

Minimum overall drop length is 30"/75cm (LT282) and 32.5"/82cm (LT283). Lengths over 96"/245cm (LT282) and 98.5"/252cm (LT283) available at additional cost

Specify fabric-wrapped electrical cord color: black, blue, gold, or gray

Bulbs included

Standard metal finishes: dark oxidized / brushed brass (other finishes available on request)

Five glass colors available (including clear)

Four fabric-wrapped electrical cord colors available

All glass dimensions are approximate – handblown glass dimensions vary by nature and intent

Handblown in the Czech Republic

transparent colors:



clear-CLR



olivin-OLV



smoke-SMK

opaque colors:



new blue-NBL



white-WHT

LT282 ---	drape circle 12 chandelier dark oxidized	4.5"Dia (11cm) glass	44"Dia (112cm)
LT282 --- B	drape circle 12 chandelier brushed brass	4.5"Dia (11cm) glass	44"Dia (112cm)
LT283 ---	drape circle 12 chandelier dark oxidized	7"Dia (18cm) glass	46.5"Dia (119cm)
LT283 --- B	drape circle 12 chandelier brushed brass	7"Dia (18cm) glass	46.5"Dia (119cm)

cord colors available

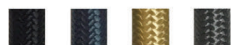

black blue gold gray

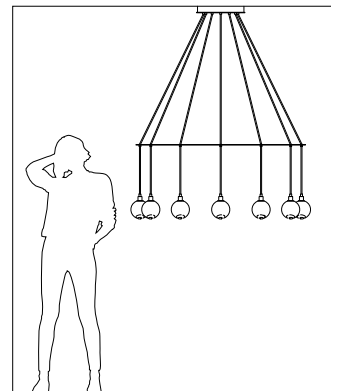

SkLO



drape circle 18 *chandelier*



drape circle 18 chandelier shown with opaque white glass, dark oxidized metal finish and black fabric-wrapped cord

drape circle 18 chandelier

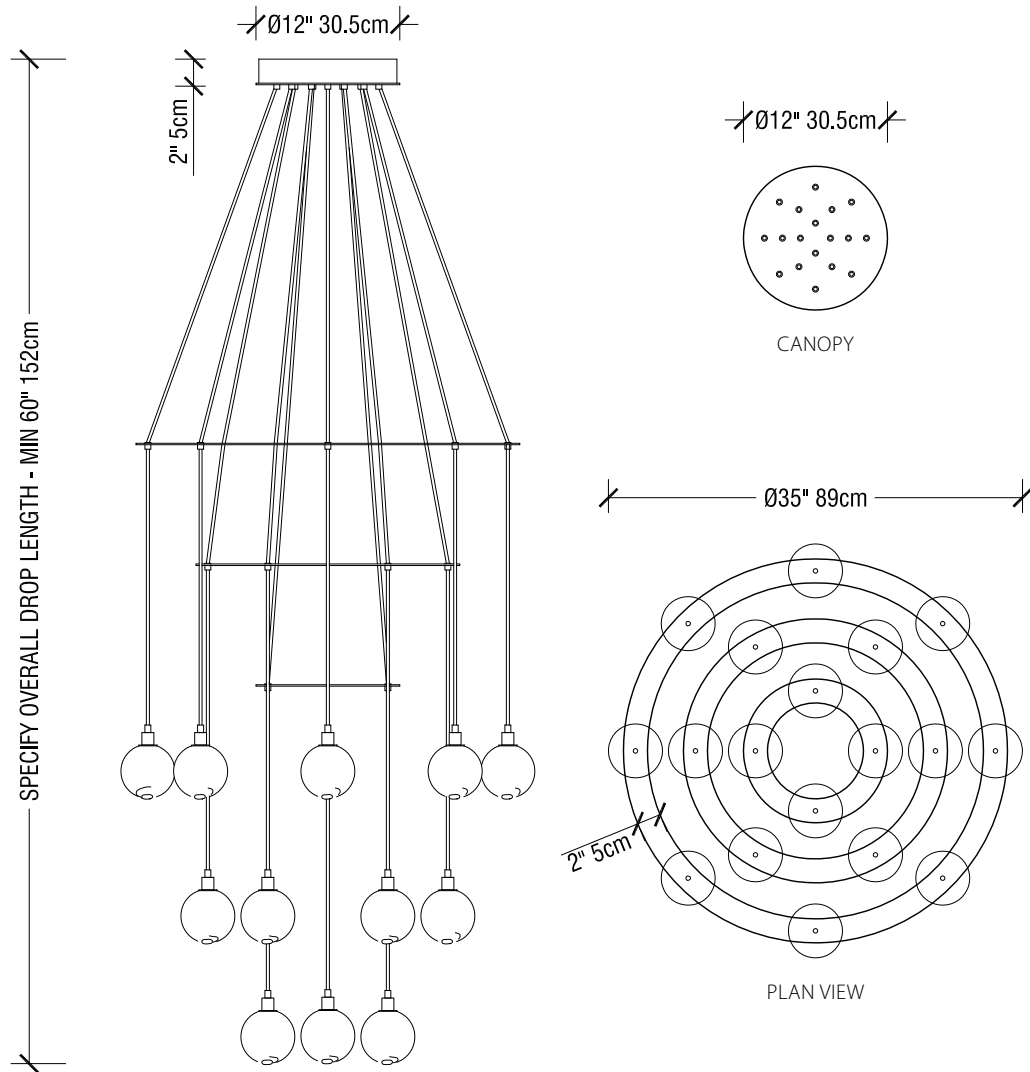

The *drape circle 18* chandelier consists of 18 individual pendants gathered and supported by a series of brass rings. Each pendant features a 4 1/2" (11 cm) diameter sphere of handblown Czech glass suspended on a fabric-wrapped electrical cord. The cords pass through and support the rings. The spherical glass diffusers feature the signature SkLO double-dipped, fire-polished mouths which show where the glass is broken from the blower's pipe, making each unique.

UL LISTED SUITABLE FOR DAMP LOCATIONS (US & CANADA)

Sockets: 120V E12 (candelabra) 7W Max (G9 sockets available on request)

Canopy: Brass canopy with exposed fasteners and steel mounting plate. Recessed electrical box required for installation

Minimum overall drop length is 60" (152cm). Lengths over 96" (245cm) available at additional cost

Specify fabric-wrapped electrical cord color: black, blue, gold, or gray

Bulbs included

Standard metal finishes: dark oxidized / brushed brass (other finishes available on request)

Five glass colors available (including clear)

Four fabric-wrapped electrical cord colors available

All glass dimensions are approximate – handblown glass dimensions vary by nature and intent

Handblown in the Czech Republic

transparent colors:



clear-CLR



olivin-OLV



smoke-SMK

opaque colors:



new blue-NBL



white-WHT

LT285 --- **drape circle 18 chandelier** dark oxidized

LT285 --- B **drape circle 18 chandelier** brushed brass

35"Dia (89cm)

35"Dia (89cm)

cord colors available



black blue gold gray

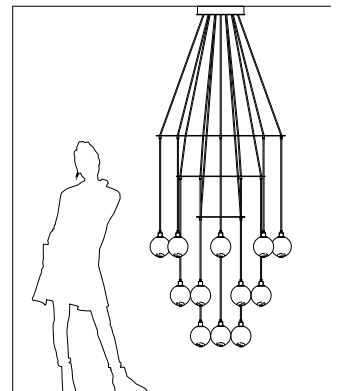

drape circle 28 *chandelier*



*drape circle 28 chandelier shown in an elongated composition (14 foot / 410cm overall drop length)
with a palette of dark oxidized brass, black fabric-wrapped cord and white glass*

drape circle 28 chandelier

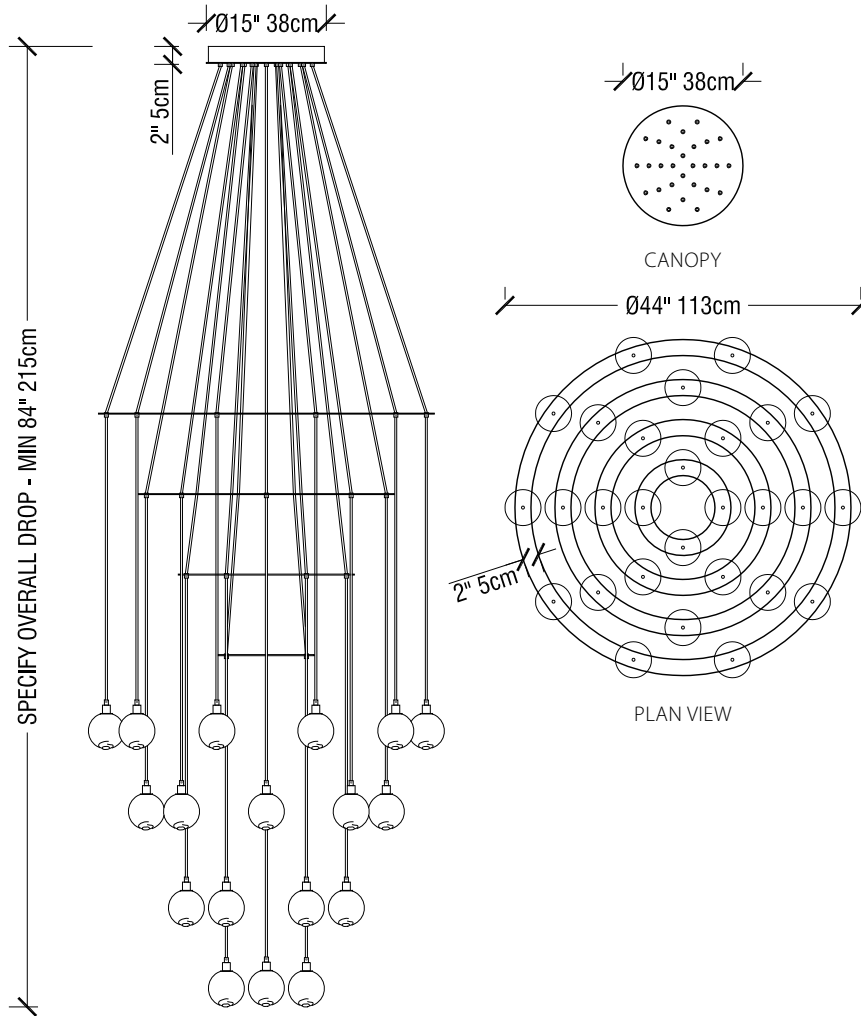

The *drape circle 28* chandelier consists of 28 individual pendants gathered and supported by a series of brass rings. Each pendant features a 4 1/2" (11cm) diameter sphere of handblown Czech glass suspended on a fabric-wrapped electrical cord. The cords pass through and support the rings. The spherical glass diffusers feature the signature SkLO double-dipped, fire-polished mouths which show where the glass is broken from the blower's pipe, making each unique.

UL LISTED SUITABLE FOR DAMP LOCATIONS (US & CANADA)

Sockets: 120V E12 (candelabra) 7W Max (G9 sockets available on request)

Canopy: Brass canopy with exposed fasteners and steel mounting plate. Recessed electrical box required for installation

Specify overall drop length – different proportions and compositions are possible – please specify

Minimum overall drop length is 84" (215cm). Lengths over 120" (305cm) available at additional cost

Specify fabric-wrapped electrical cord color: black, blue, gold, or gray

Bulbs included

Standard metal finishes: dark oxidized / brushed brass (other finishes available on request)

Five glass colors available (including clear)

Four fabric-wrapped electrical cord colors available

All glass dimensions are approximate – handblown glass dimensions vary by nature and intent

Handblown in the Czech Republic

transparent colors:



clear-CLR



olivin-OLV



smoke-SMK

opaque colors:



new blue-NBL



white-WHT

LT286 --- drape circle 28 chandelier dark oxidized

LT286 --- B drape circle 28 chandelier brushed brass

44"Dia (113cm)

44"Dia (113cm)

cord colors available



black blue gold gray

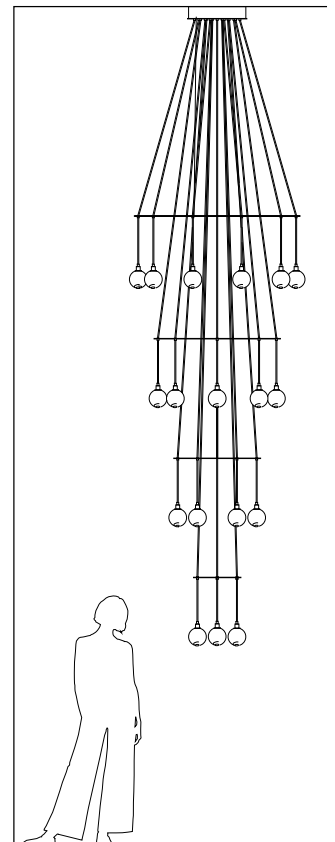

drape cluster 7 *pendant*



drape cluster 7 pendant shown with 4 1/2" opaque white glass, brushed brass metal finish and blue fabric-wrapped cord

drape cluster 7 pendant

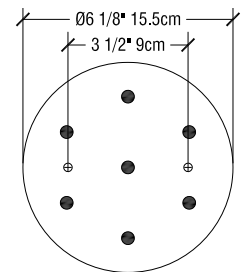
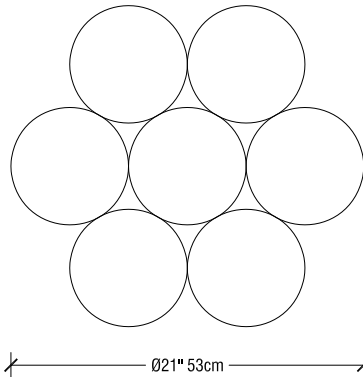
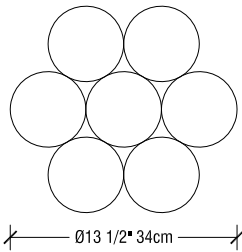
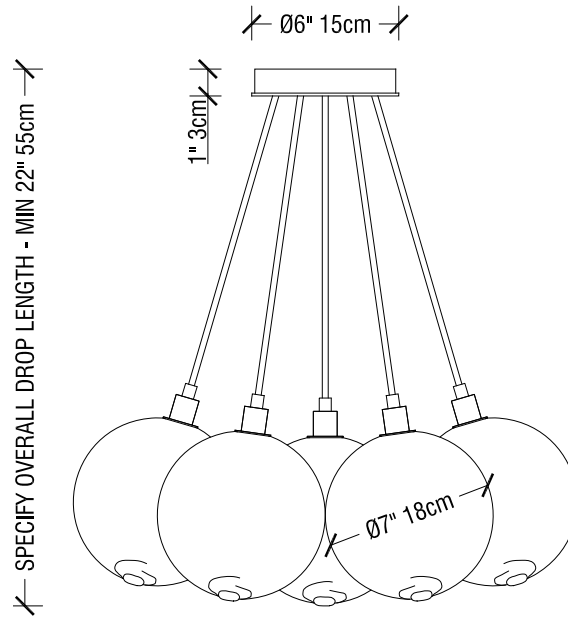
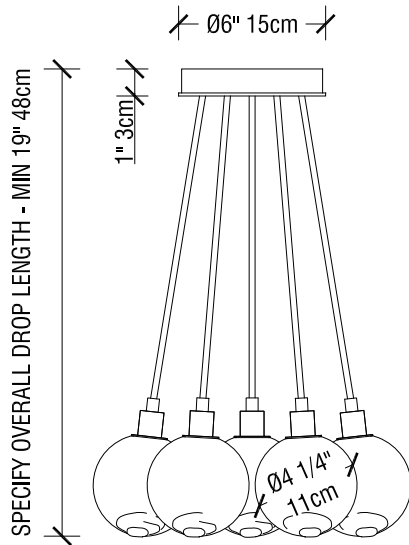

CANOPY - BOTTOM VIEW

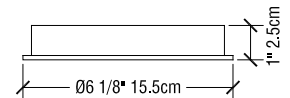

CANOPY - SIDE VIEW



The *drape cluster 7* consists of seven individual pendants clustered into a neat geometric group. Each pendant features a 4 1/2" (11cm) or 7" (18cm) diameter sphere of handblown Czech glass individually suspended on fabric-wrapped cord. The spherical glass diffusers feature the signature SkLO double-dipped, fire-polished mouths which show where the glass is broken from the blower's pipe, making each unique.

UL LISTED SUITABLE FOR DAMP LOCATIONS (US & CANADA)

Sockets: 120V E12 (candelabra) 7W Max (G9 sockets available on request)

Canopy: Brass canopy with exposed fasteners. Recessed steel electrical box required for installation

Specify overall drop length

Minimum overall drop length is 19"/48cm (LT175) and 22"/55cm (LT185). Lengths over 43"/109cm (LT175) and 46"/117cm (LT185) available at additional cost

Specify fabric-wrapped electrical cord color: black, blue, gold, or gray

Bulbs included

Standard metal finishes: dark oxidized / brushed brass (other finishes available on request)

Five glass colors available (including clear)

Four fabric-wrapped electrical cord colors available

All glass dimensions are approximate – handblown glass dimensions vary by nature and intent

Handblown in the Czech Republic

transparent colors:



clear-CLR



olivin-OLV



smoke-SMK

opaque colors:



new blue-NBL



white-WHT

LT175 ---	drape cluster 7 pendant	dark oxidized	4.5"Dia (11cm) glass	13.5"Dia (34cm)
LT175 --- B	drape cluster 7 pendant	brushed brass	4.5"Dia (11cm) glass	13.5"Dia (34cm)
LT185 ---	drape cluster 7 pendant	dark oxidized	7"Dia (18cm) glass	21"Dia (53cm)
LT185 --- B	drape cluster 7 pendant	brushed brass	7"Dia (18cm) glass	21"Dia (53cm)

cord colors available

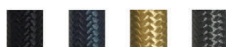

black blue gold gray

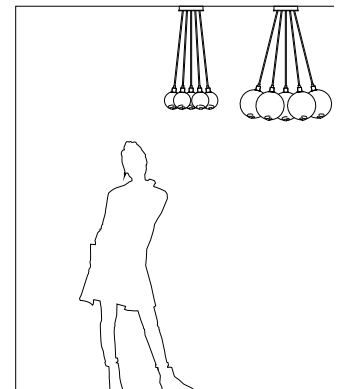

drape composition 1 *pendant*



drape composition 1 pendant shown with opaque white glass, brushed brass metal finish and black fabric-wrapped cord

drape composition 1 pendant

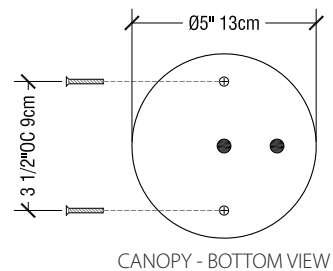
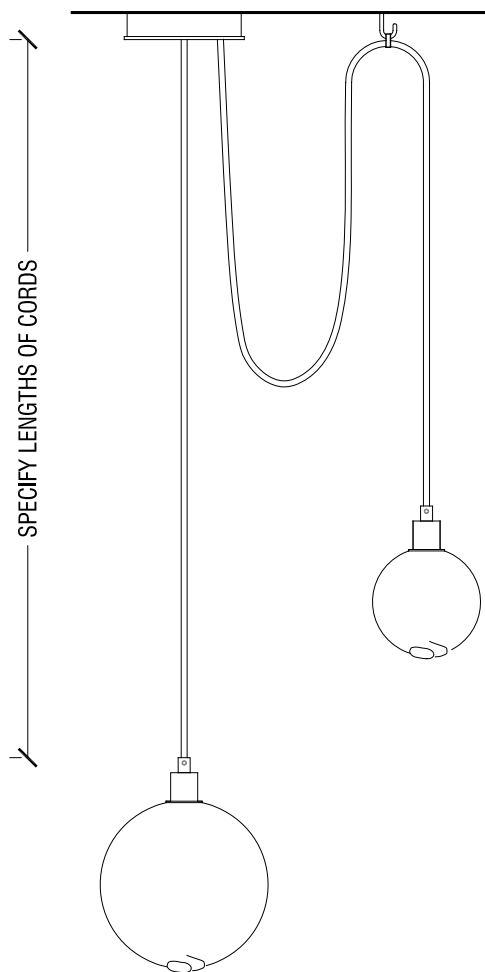

CANOPY - BOTTOM VIEW

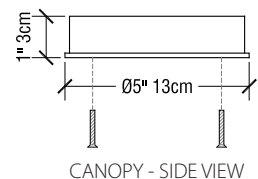

CANOPY - SIDE VIEW



The *drape composition 1* is a pendant fixture with two spheres of handblown Czech glass suspended by fabric-wrapped electrical cords from a single canopy. One sphere is 4 1/2" (11 cm) diameter, the other is 7" (18 cm) diameter. The small sphere comes with a brass loop attached to the cord and is then hung from the included brass ceiling hook; the large sphere hangs straight down. The spherical glass diffusers feature the signature SkLO double-dipped, fire-polished mouths which show where the glass is broken from the blower's pipe, making each unique.

UL LISTED SUITABLE FOR DAMP LOCATIONS (US & CANADA)

Sockets: 120V E12 (candelabra) 7W Max (G9 sockets available on request)

Canopy: Brass canopy with exposed fasteners. Recessed steel electrical box required for installation

Pendant suspended from canopy on fabric-wrapped electrical cords

Specify lengths of cords. Lengths over 72" (180cm) available at additional cost

Specify fabric-wrapped electrical cord color: black, blue, gold, or gray

Bulbs included

Standard metal finishes: dark oxidized / brushed brass (other finishes available on request)

Two glass color combinations available: all white / blue palette

Four fabric-wrapped electrical cord colors available

All glass dimensions are approximate – handblown glass dimensions vary by nature and intent

Handblown in the Czech Republic

glass colors: blue palette-PBL white-WHT

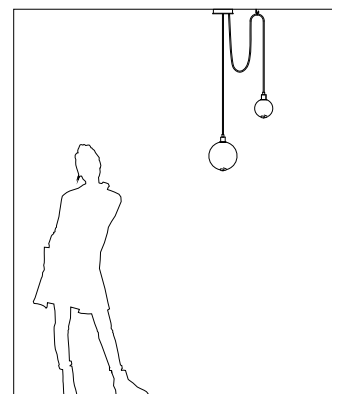

LT181 --- drape composition 1 pendant dark oxidized

LT181 --- B drape composition 1 pendant brushed brass

cord colors available



black blue gold gray



drape composition 2 *pendant*



drape composition 2 pendant shown in blue palette glass, brushed brass metal finish and black fabric-wrapped cord

drape composition 2 pendant

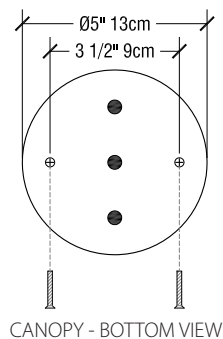
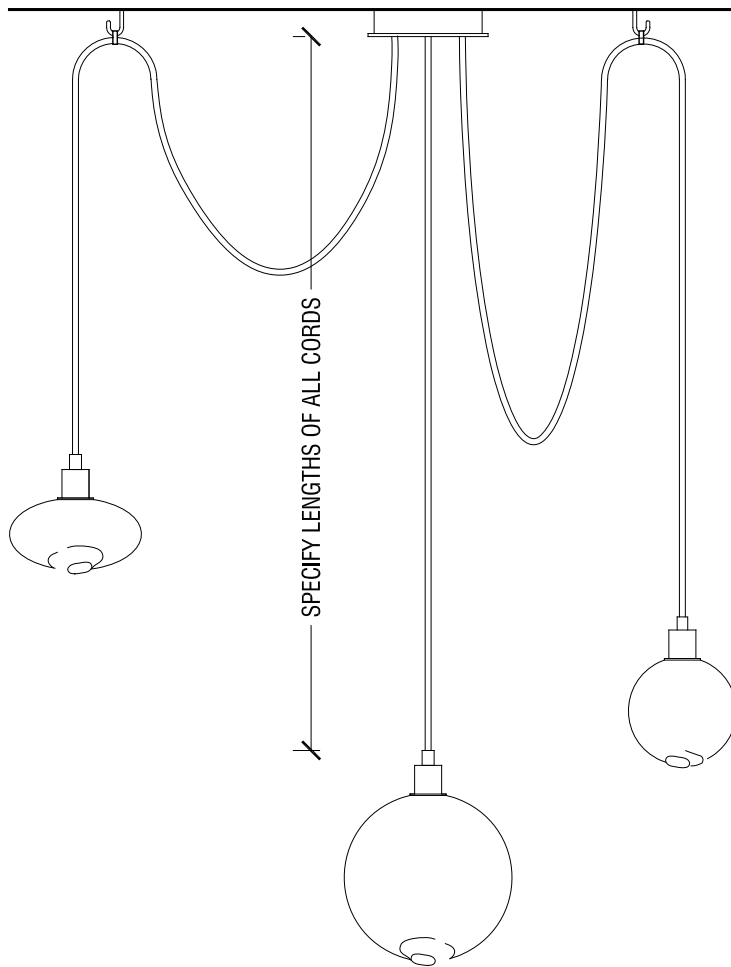

CANOPY - BOTTOM VIEW

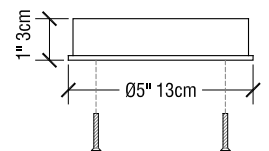

CANOPY - SIDE VIEW



The *drape composition 2* is a pendant fixture with three shapes of handblown Czech glass suspended by fabric-wrapped electrical cords from a single canopy. One is a 4 1/2" (11 cm) diameter sphere, the second is a 5"W x 3"H (13x7cm) ovoid, the third is a 7" (18cm) diameter sphere. The two smaller shapes come with a brass loop attached to the cord and are then hung from the included brass ceiling hooks; the large sphere hangs straight down. The glass diffusers feature the signature SkLO double-dipped, fire-polished mouths which show where the glass is broken from the blower's pipe, making each unique.

UL LISTED SUITABLE FOR DAMP LOCATIONS (US & CANADA)

Sockets: 120V E12 (candelabra) 7W Max (G9 sockets available on request)

Canopy: Brass canopy with exposed fasteners. Recessed steel electrical box required for installation

Pendant suspended from canopy on fabric-wrapped electrical cords

Specify lengths of cords. Lengths over 72" (180cm) available at additional cost

Specify fabric-wrapped electrical cord color: black, blue, gold, or gray

Bulbs included

Standard metal finishes: dark oxidized / brushed brass (other finishes available on request)

Two glass color combinations available: all white / blue palette

Four fabric-wrapped electrical cord colors available

All glass dimensions are approximate – handblown glass dimensions vary by nature and intent

Handblown in the Czech Republic

glass colors: blue palette-PBL white-WHT

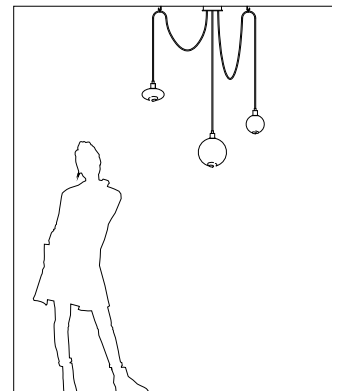

LT182 --- drape composition 2 pendant dark oxidized

LT182 --- B drape composition 2 pendant brushed brass

cord colors available



black blue gold gray



Apr 2020

drape hook *pendant*



drape hook 7 pendant shown with opaque white glass, dark oxidized metal finish and black fabric-wrapped cord

drape hook 3 *pendant*

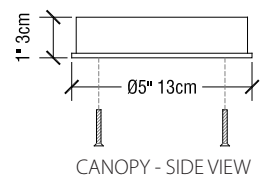
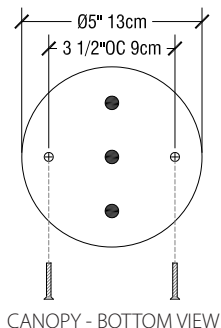
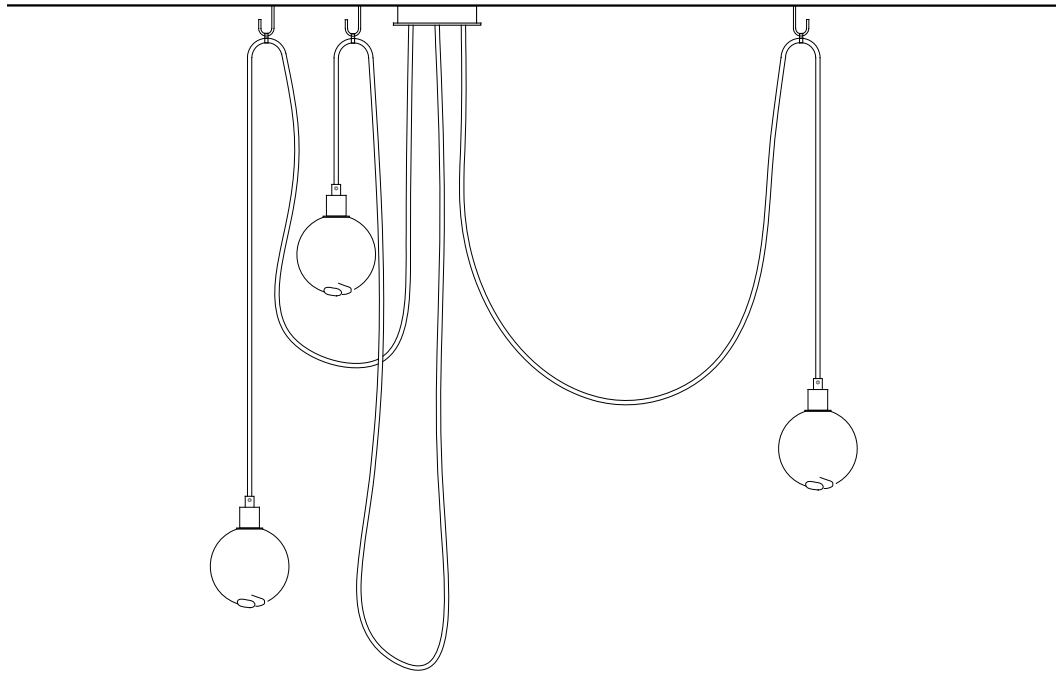

The *drape hook* pendants are a series of organic multi-light fixtures that allow for infinite composition and variation. Available in nine, seven, five, and three-light versions, *drape hook* offers a unique ability to integrate into architecture and interiors. It consists of multiple 4 1/2" (11 cm) diameter pendants of handblown Czech glass individually suspended from a single canopy on fabric-wrapped cords. The spherical glass diffusers feature the signature SkLO double-dipped, fire-polished mouths which show where the glass is broken from the blower's pipe, making each unique. Each individual cord comes with a custom solid brass loop attached, allowing for the individual pendants to be composed and hung from their individual solid brass ceiling hooks (included).

UL LISTED SUITABLE FOR DAMP LOCATIONS (US & CANADA)
 Sockets: 120V E12 (candelabra) 7W Max (G9 sockets available on request)
 Canopy: Brass canopy with exposed fasteners. Recessed steel electrical box required for installation
 Specify lengths of cords. Lengths over 72" (180cm) available at additional cost
 Specify fabric-wrapped electrical cord color: black, blue, gold, or gray
 Bulbs included

Standard metal finishes: dark oxidized / brushed brass (other finishes available on request)
 Five glass colors available (including clear)
 Four fabric-wrapped electrical cord colors available
 All glass dimensions are approximate – handblown glass dimensions vary by nature and intent
 Handblown in the Czech Republic

transparent colors:



opaque colors:



LT172 --- drape hook 3 *pendant* dark oxidized
 LT172 --- B drape hook 3 *pendant* brushed brass

cord colors available

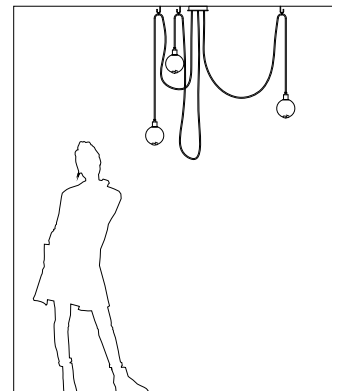

drape hook 5 pendant

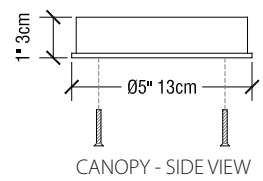
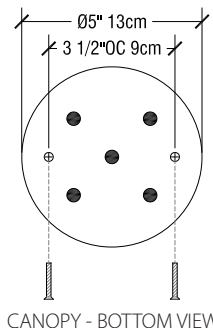
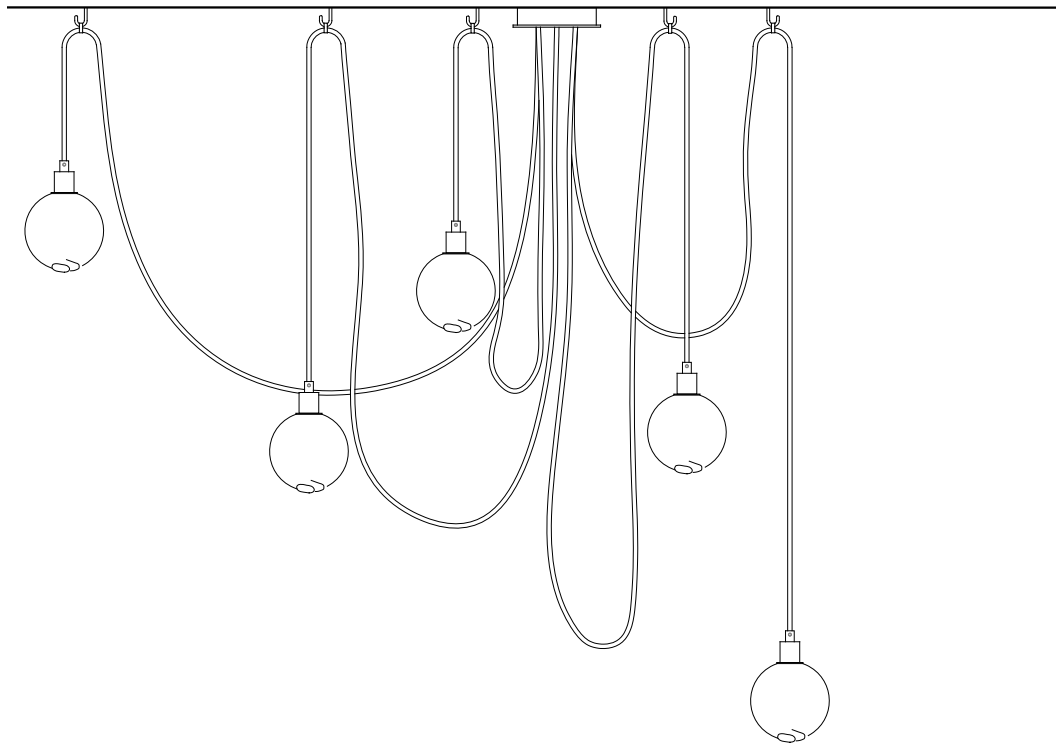

The *drape hook* pendants are a series of organic multi-light fixtures that allow for infinite composition and variation. Available in nine, seven, five, and three-light versions, *drape hook* offers a unique ability to integrate into architecture and interiors. It consists of multiple 4 1/2" (11 cm) diameter pendants of handblown Czech glass individually suspended from a single canopy on fabric-wrapped cords. The spherical glass diffusers feature the signature SkLO double-dipped, fire-polished mouths which show where the glass is broken from the blower's pipe, making each unique. Each individual cord comes with a custom solid brass loop attached, allowing for the individual pendants to be composed and hung from their individual solid brass ceiling hooks (included).

UL LISTED SUITABLE FOR DAMP LOCATIONS (US & CANADA)
 Sockets: 120V E12 (candelabra) 7W Max (G9 sockets available on request)
 Canopy: Brass canopy with exposed fasteners. Recessed steel electrical box required for installation
 Specify lengths of cords. Lengths over 72" (180cm) available at additional cost
 Specify fabric-wrapped electrical cord color: black, blue, gold, or gray
 Bulbs included

Standard metal finishes: dark oxidized / brushed brass (other finishes available on request)
 Five glass colors available (including clear)
 Four fabric-wrapped electrical cord colors available
 All glass dimensions are approximate – handblown glass dimensions vary by nature and intent
 Handblown in the Czech Republic

transparent colors:



opaque colors:



LT174 --- drape hook 5 pendant dark oxidized
 LT174 --- B drape hook 5 pendant brushed brass

cord colors available

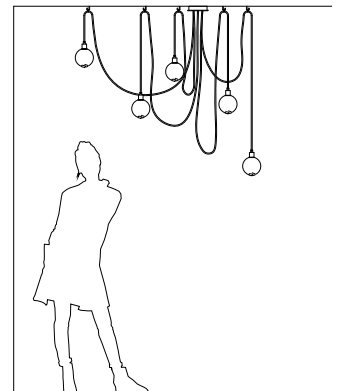

drape hook 7 pendant

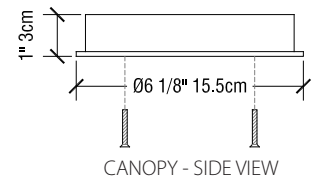
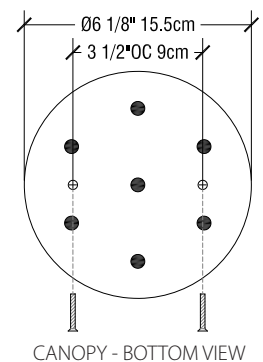
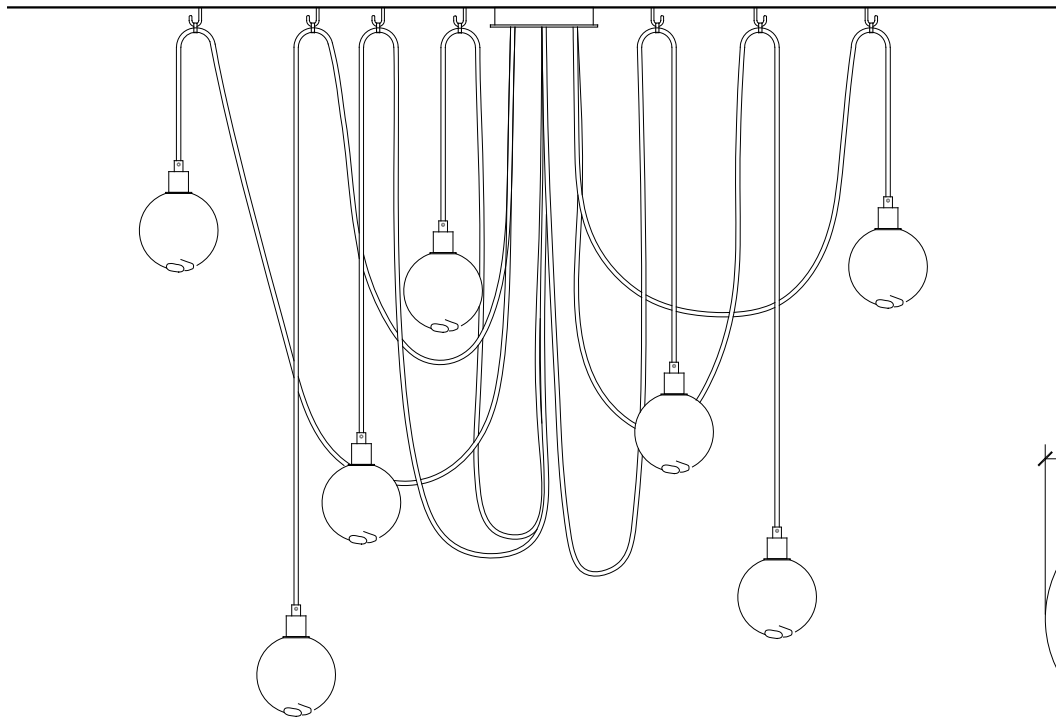

The *drape hook* pendants are a series of organic multi-light fixtures that allow for infinite composition and variation. Available in nine, seven, five, and three-light versions, *drape hook* offers a unique ability to integrate into architecture and interiors. It consists of multiple 4 1/2" (11 cm) diameter pendants of handblown Czech glass individually suspended from a single canopy on fabric-wrapped cords. The spherical glass diffusers feature the signature SkLO double-dipped, fire-polished mouths which show where the glass is broken from the blower's pipe, making each unique. Each individual cord comes with a custom solid brass loop attached, allowing for the individual pendants to be composed and hung from their individual solid brass ceiling hooks (included).

UL LISTED SUITABLE FOR DAMP LOCATIONS (US & CANADA)

Sockets: 120V E12 (candelabra) 7W Max (G9 sockets available on request)

Canopy: Brass canopy with exposed fasteners. Recessed steel electrical box required for installation

Specify lengths of cords. Lengths over 72" (180cm) available at additional cost

Specify fabric-wrapped electrical cord color: black, blue, gold, or gray

Bulbs included

Standard metal finishes: dark oxidized / brushed brass (other finishes available on request)

Five glass colors available (including clear)

Four fabric-wrapped electrical cord colors available

All glass dimensions are approximate – handblown glass dimensions vary by nature and intent

Handblown in the Czech Republic

transparent colors:



clear-CLR



olivin-OLV



smoke-SMK

opaque colors:



new blue-NBL



white-WHT

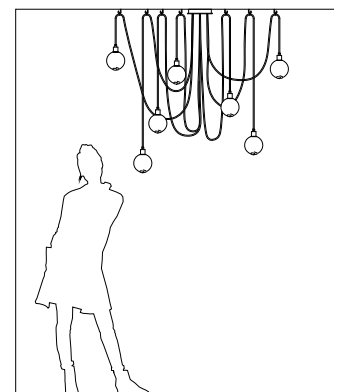

LT176 --- drape hook 7 pendant dark oxidized

LT176 --- B drape hook 7 pendant brushed brass

cord colors available

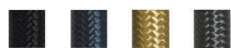

black blue gold gray



drape hook 9 pendant

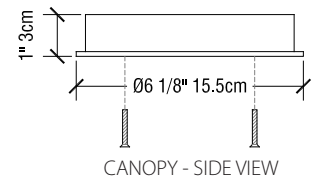
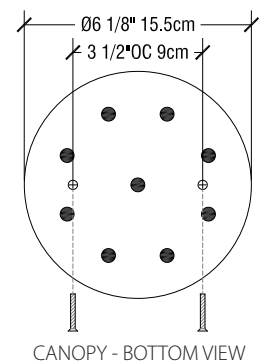
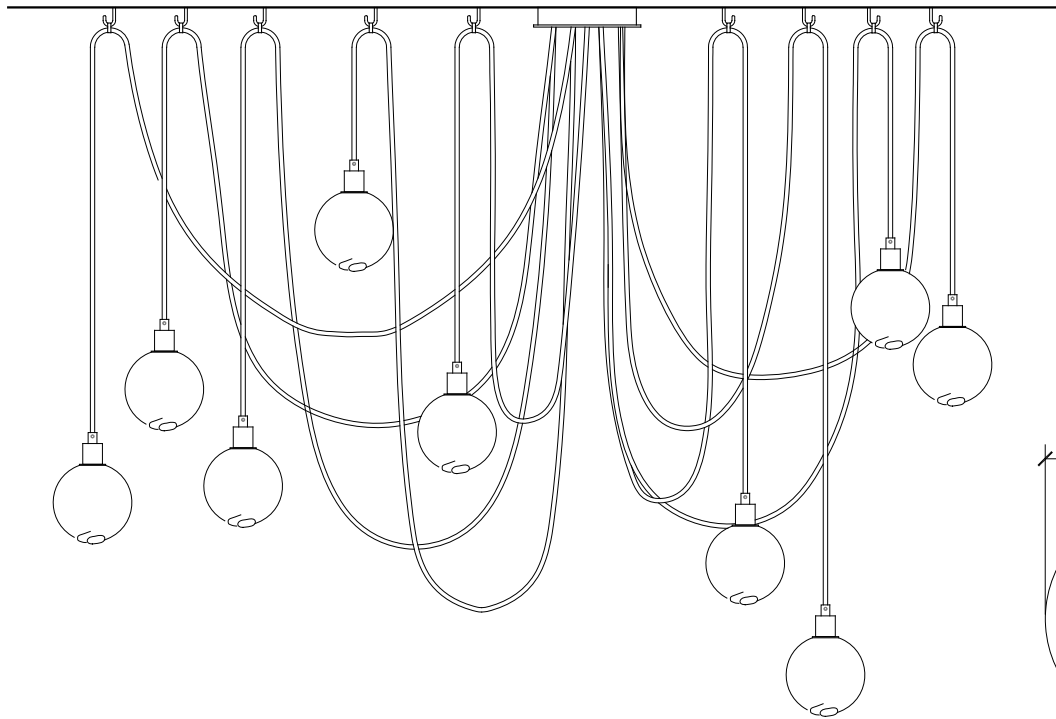

The *drape hook* pendants are a series of organic multi-light fixtures that allow for infinite composition and variation. Available in nine, seven, five, and three-light versions, *drape hook* offers a unique ability to integrate into architecture and interiors. It consists of multiple 4 1/2" (11 cm) diameter pendants of handblown Czech glass individually suspended from a single canopy on fabric-wrapped cords. The spherical glass diffusers feature the signature SkLO double-dipped, fire-polished mouths which show where the glass is broken from the blower's pipe, making each unique. Each individual cord comes with a custom solid brass loop attached, allowing for the individual pendants to be composed and hung from their individual solid brass ceiling hooks (included).

UL LISTED SUITABLE FOR DAMP LOCATIONS (US & CANADA)
 Sockets: 120V E12 (candelabra) 7W Max (G9 sockets available on request)
 Canopy: Brass canopy with exposed fasteners. Recessed steel electrical box required for installation
 Specify lengths of cords. Lengths over 72" (180cm) available at additional cost
 Specify fabric-wrapped electrical cord color: black, blue, gold, or gray
 Bulbs included

Standard metal finishes: dark oxidized / brushed brass (other finishes available on request)
 Five glass colors available (including clear)
 Four fabric-wrapped electrical cord colors available
 All glass dimensions are approximate – handblown glass dimensions vary by nature and intent
 Handblown in the Czech Republic

transparent colors:



opaque colors:

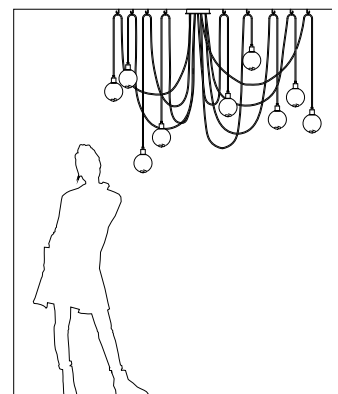

LT177 --- drape hook 9 pendant dark oxidized
 LT177 --- B drape hook 9 pendant brushed brass

cord colors available



drape linear 7 *chandelier*



drape linear 7 chandelier shown with opaque white glass, dark oxidized metal finish and gold fabric-wrapped cord

drape linear 7 chandelier

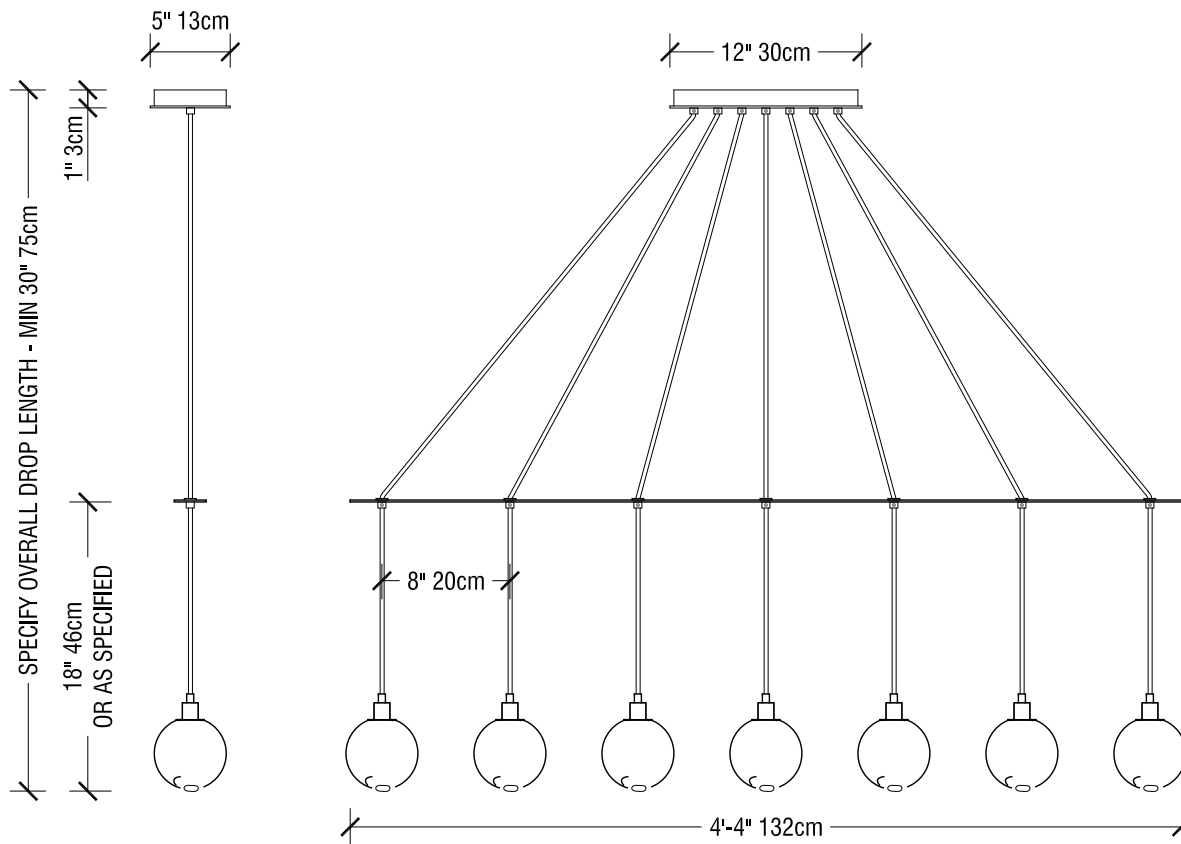

The *drape linear 7* chandelier consists of 7 individual pendants gathered into a straight line by a solid brass bar. Each pendant features a 4 1/2" (11 cm) diameter sphere of handblown Czech glass suspended on a fabric-wrapped electrical cord. The cords pass through the bar. The spherical glass diffusers feature the signature SkLO double-dipped, fire-polished mouths which show where the glass is broken from the blower's pipe, making each unique.

UL LISTED SUITABLE FOR DAMP LOCATIONS (US & CANADA)
 Sockets: 120V E12 (candelabra) 7W Max (G9 sockets available on request)
 Canopy: Brass canopy with exposed fasteners and steel mounting plate. Recessed electrical box required for installation
 Specify overall drop length – see drawing for additional required specification
 Minimum overall drop length is 30" (75cm). Lengths over 96" (245cm) available at additional cost
 Specify fabric-wrapped electrical cord color: black, blue, gold, or gray
 Bulbs included

Standard metal finishes: dark oxidized / brushed brass (other finishes available on request)
 Five glass colors available (including clear)
 Four fabric-wrapped electrical cord colors available
 All glass dimensions are approximate – handblown glass dimensions vary by nature and intent
 Handblown in the Czech Republic

transparent colors:



clear-CLR



olivin-OLV



smoke-SMK

opaque colors:



new blue-NBL



white-WHT

LT400 --- drape linear 7 chandelier dark oxidized
 LT400 --- B drape linear 7 chandelier brushed brass

4'-4"L (132cm)
 4'-4"L (132cm)

cord colors available

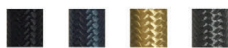

black blue gold gray

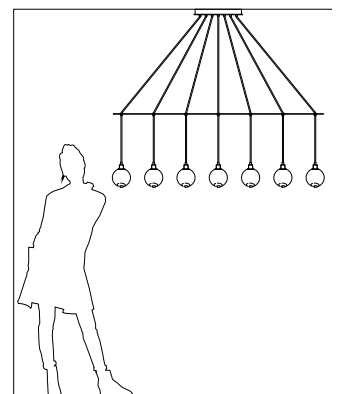

drape skirt 9 *chandelier*



drape skirt 9 chandelier shown with opaque white glass, brushed brass metal finish and blue fabric-wrapped cord

drape skirt 9 chandelier

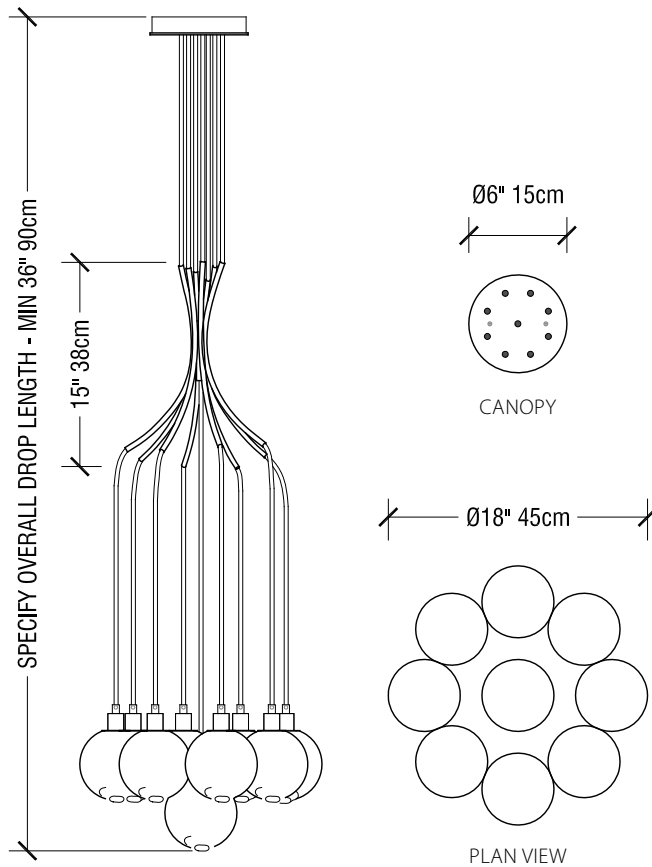

The *drape skirt 9* chandelier consists of 9 individual pendants gathered and supported by a central brass "skirt" structure. Each pendant features a 4 1/2" (11cm) diameter sphere of handblown Czech glass suspended on a fabric-wrapped electrical cord. The cords pass through the tubes of the skirt. The spherical glass diffusers feature the signature SkLO double-dipped, fire-polished mouths which show where the glass is broken from the blower's pipe, making each unique.

UL LISTED SUITABLE FOR DAMP LOCATIONS (US & CANADA)

Sockets: 120V E12 (candelabra) 7W Max (G9 sockets available on request)

Canopy: Brass canopy with exposed fasteners. Recessed steel electrical box required for installation

Specify overall drop length

Minimum overall drop length is 36" (90cm). Lengths over 96" (245cm) available at additional cost

Specify fabric-wrapped electrical cord color: black, blue, gold, or gray

Bulbs included

Standard metal finishes: dark oxidized / brushed brass (other finishes available on request)

Five glass colors available (including clear)

Four fabric-wrapped electrical cord colors available

All glass dimensions are approximate – handblown glass dimensions vary by nature and intent

Handblown in the Czech Republic

transparent colors:



clear-CLR



olivin-OLV



smoke-SMK

opaque colors:



new blue-NBL



white-WHT

LT295 --- drape skirt 9 chandelier dark oxidized

18"Dia (45cm)

LT295 --- B drape skirt 9 chandelier brushed brass

18"Dia (45cm)

cord colors available

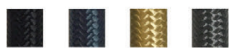

black blue gold gray

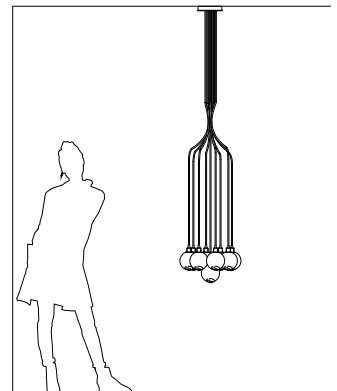

drape skirt 15 *chandelier*



drape skirt 15 chandelier shown with opaque white glass, brushed brass metal finish and black fabric-wrapped cord

drape skirt 15 chandelier

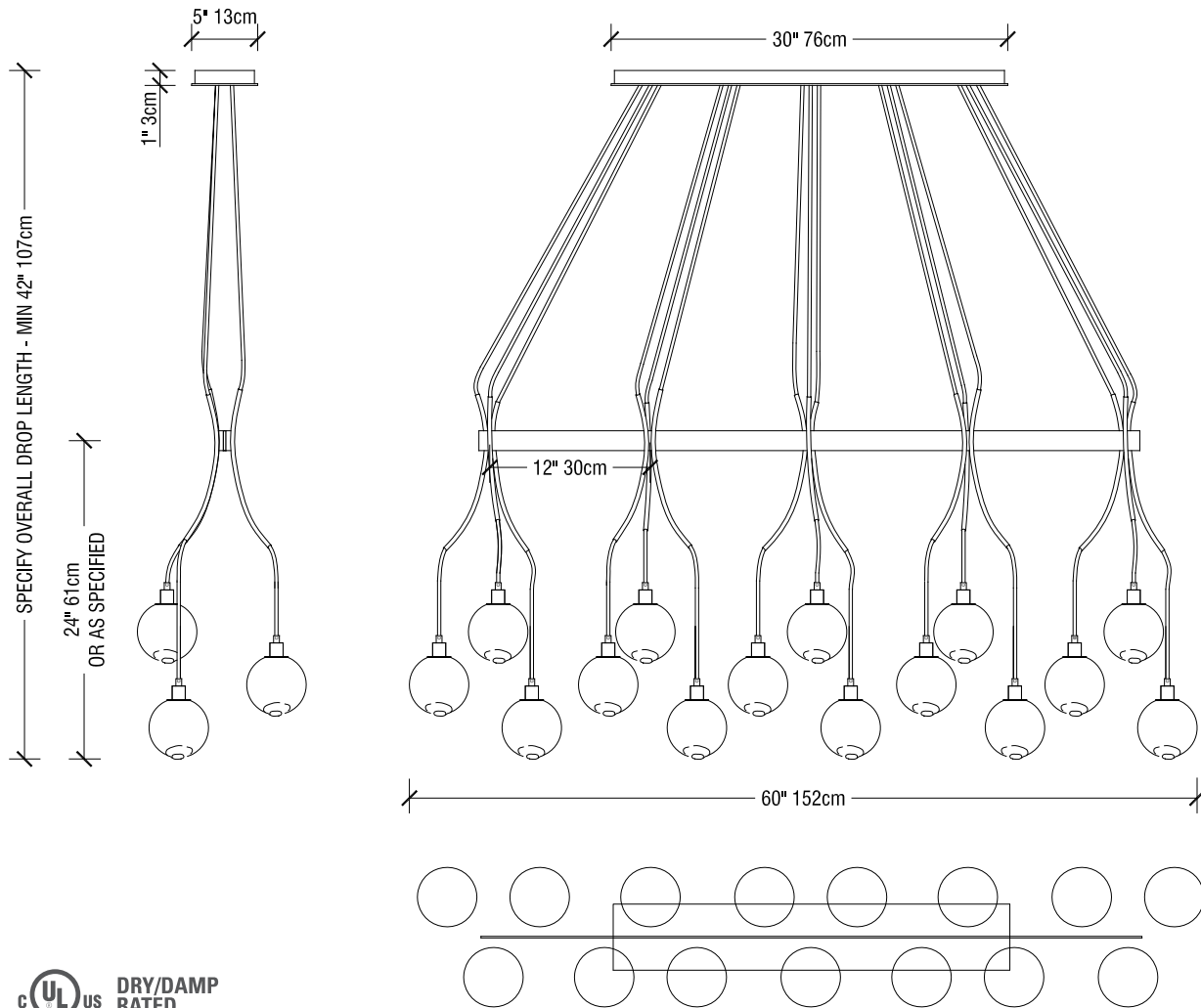

The *drape skirt 15* chandelier consists of 15 individual pendants gathered into groups of 3 and supported by a series of 5 brass "skirt" structures along a brass bar. Each pendant features a 4 1/2" (11cm) diameter sphere of handblown Czech glass suspended on a fabric-wrapped electrical cord. The cords pass through the tubes of the skirts. The spherical glass diffusers feature the signature SkLO double-dipped, fire-polished mouths which show where the glass is broken from the blower's pipe, making each unique.

UL LISTED SUITABLE FOR DAMP LOCATIONS (US & CANADA)

Sockets: 120V E12 (candelabra) 7W Max (G9 sockets available on request)

Canopy: Brass canopy with exposed fasteners and steel mounting plate. Recessed electrical box required for installation

Specify overall drop length – see drawing for additional required specification

Minimum overall drop length is 42" (107cm). Lengths over 96" (245cm) available at additional cost

Specify fabric-wrapped electrical cord color: black, blue, gold, or gray

Bulbs included

Standard metal finishes: dark oxidized / brushed brass (other finishes available on request)

Five glass colors available (including clear)

Four fabric-wrapped electrical cord colors available

All glass dimensions are approximate – handblown glass dimensions vary by nature and intent

Handblown in the Czech Republic

transparent colors:



clear-CLR



olivin-OLV



smoke-SMK

opaque colors:



new blue-NBL



white-WHT

LT290 --- drape skirt 15 chandelier dark oxidized

60"L (152cm)

LT290 --- B drape skirt 15 chandelier brushed brass

60"L (152cm)

cord colors available



black blue gold gray

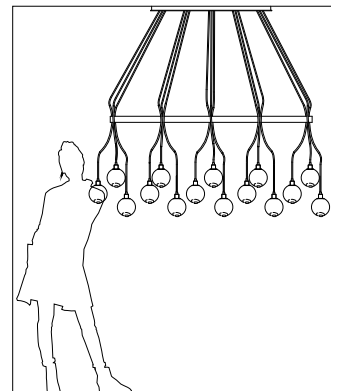

drape skirt 18 *chandelier*



drape skirt 18 chandelier shown with opaque white glass, brushed brass metal finish and gold fabric-wrapped cord

drape skirt 18 chandelier

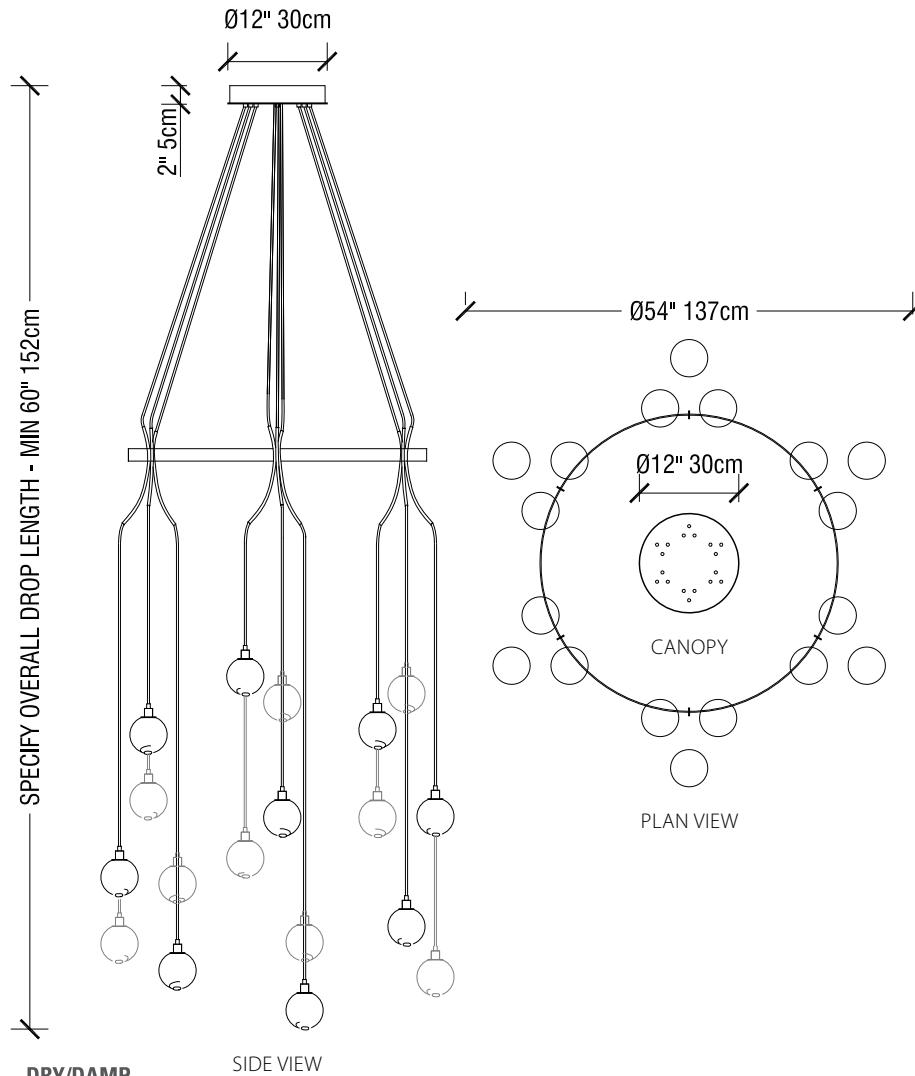

SIDE VIEW

PLAN VIEW

The SkLO *drape skirt 18* chandelier consists of 18 individual pendants gathered into groups of 3 and supported by a series of 6 brass "skirt" structures arranged around the circumference of a brass ring. Each pendant features a 4 1/2" (11cm) diameter sphere of handblown Czech glass suspended on a fabric-wrapped electrical cord. The cords pass through the tubes of the skirts. The spherical glass diffusers feature the signature SkLO double-dipped, fire-polished mouths which show where the glass is broken from the blower's pipe, making each unique.

UL LISTED SUITABLE FOR DAMP LOCATIONS (US & CANADA)

Sockets: 120V E12 (candelabra) 7W Max (G9 sockets available on request)

Canopy: Brass canopy with exposed fasteners and steel mounting plate. Recessed electrical box required for installation

Specify overall drop length

Minimum overall drop length is 60" (152cm). Lengths over 96" (245cm) available at additional cost

Specify fabric-wrapped electrical cord color: black, blue, gold, or gray

Bulbs included

Standard metal finishes: dark oxidized / brushed brass (other finishes available on request)

Five glass colors available (including clear). Four fabric-wrapped electrical cord colors available

All glass dimensions are approximate – handblown glass dimensions vary by nature and intent

Handblown in the Czech Republic

transparent colors:



clear-CLR



olivin-OLV



smoke-SMK

opaque colors:



new blue-NBL



white-WHT

LT293 --- drape skirt 18 chandelier dark oxidized

LT293 --- B drape skirt 18 chandelier brushed brass

54"Dia (137cm)

54"Dia (137cm)

cord colors available



black blue gold gray

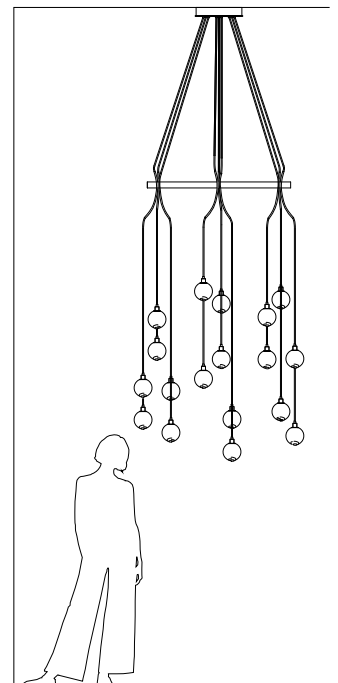

SkLO



float *pendant*



large and small float pendants shown with opaque white glass and brushed brass metal finish

float pendant

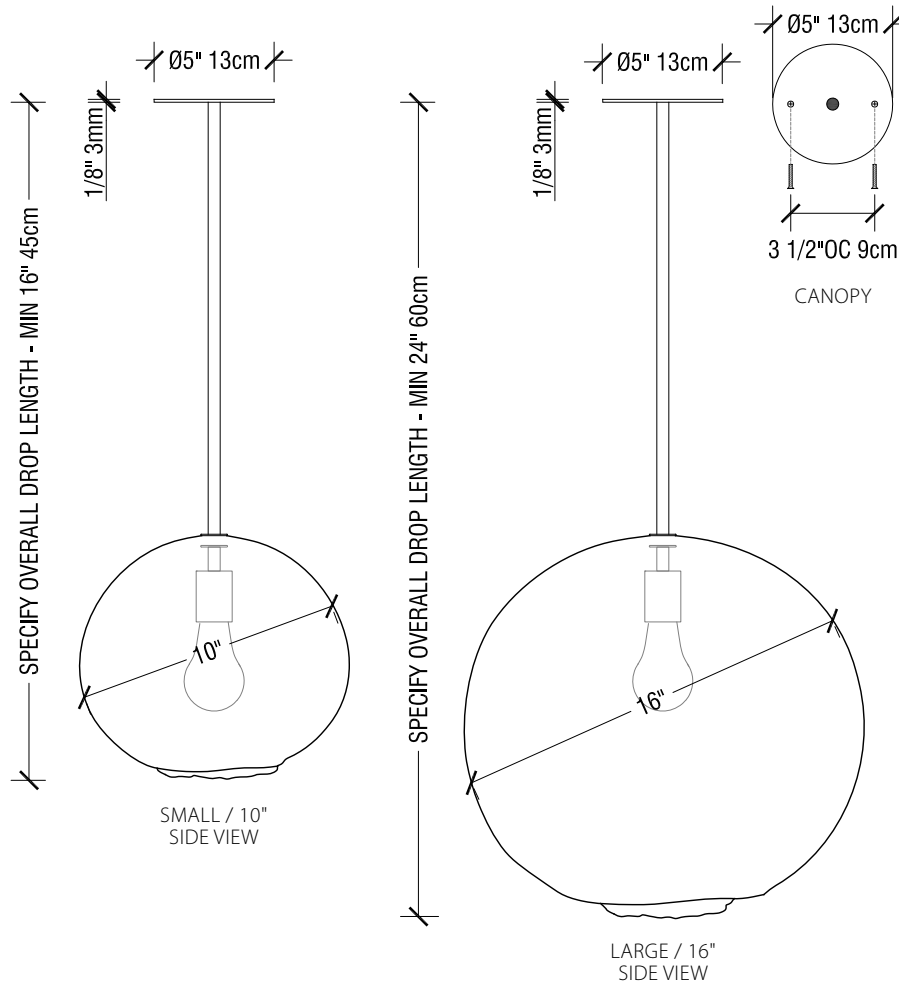

Spherical shades of handblown Czech glass with a molten, organically shaped open mouth. Available in opaque white glass, clear glass, and three transparent glass colors. Handblown, no two exactly alike.

UL LISTED SUITABLE FOR DAMP LOCATIONS (US & CANADA)

Socket: 120V E26 60W Max

Canopy: Brass canopy with exposed fasteners. Recessed steel electrical box required for installation

Pendant suspended from canopy on rigid brass stem (not field adjustable)

Specify overall drop length

Minimum overall drop length is 16"/45cm (LT251) and 24"/60cm (LT252). Lengths over 48"/122cm (LT251) and 53"/135cm (LT252) available at additional cost

Bulb included

Standard metal finishes: dark oxidized / brushed brass (other finishes available on request)

Five glass colors available (including clear)

All glass dimensions are approximate – handblown glass dimensions vary by nature and intent

Handblown in the Czech Republic

available in transparent colors:



clear-CLR



amber-AMB



olivin-OLV



smoke-SMK



white-WHT

LT251 --- float pendant small dark oxidized

LT251 --- B float pendant small brushed brass

LT252 --- float pendant large dark oxidized

LT252 --- B float pendant large brushed brass

10"Dia (25cm) glass

10"Dia (25cm) glass

16"Dia (41cm) glass

16"Dia (41cm) glass

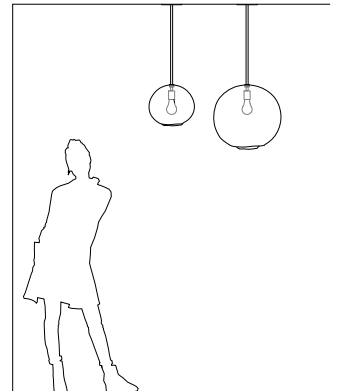

float 16/20 *light*



float 20 light shown with smoke glass and brushed brass metal finish

float 16/20 light

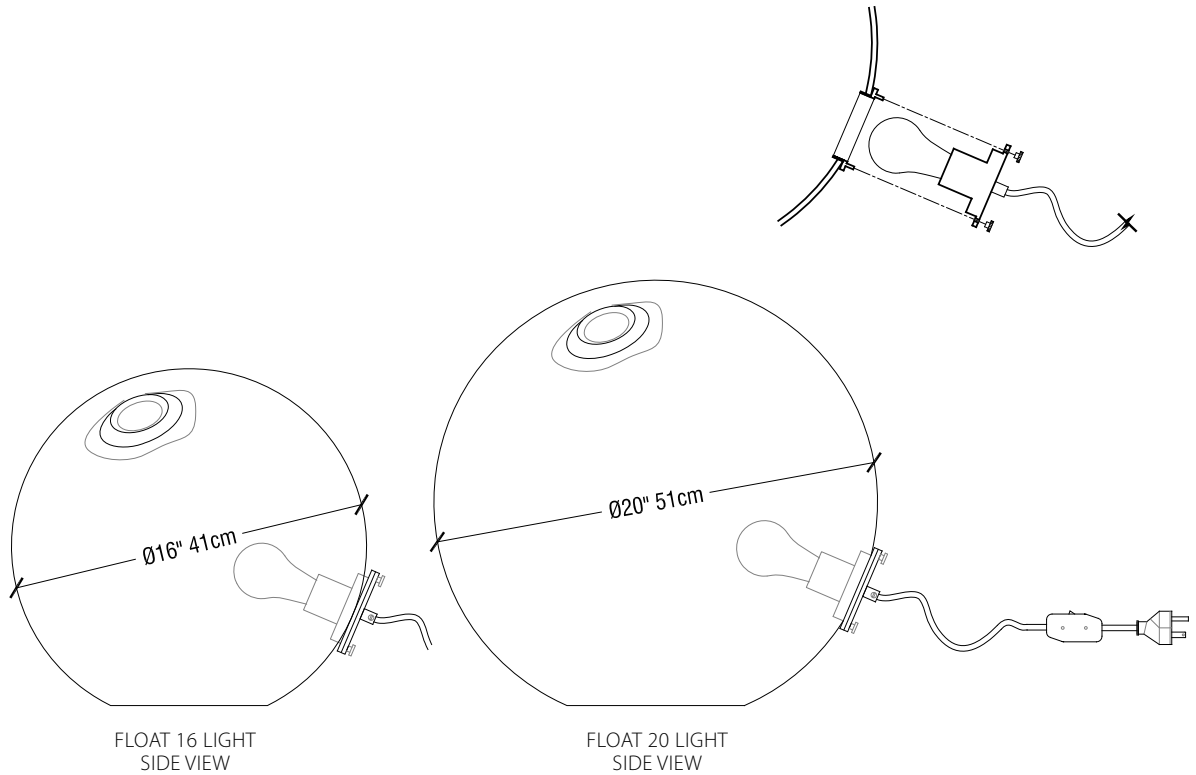

A large sphere of handblown Czech glass with a custom brass socket assembly through one side. Each glass sphere is broken hot from the blower's pipe and then the mouth is torch-polished to create a unique detail – handblown, no two exactly alike. Two thumb screws attach the removable socket from the side of the glass sphere to access the bulb. Available in two sizes and four transparent colors.

Socket: 120V E26 60W Max
6 ft (180cm) black fabric-wrapped cord with in-line switch
Bulb included

Standard metal finishes: dark oxidized / brushed brass (other finishes available on request)
Four glass colors available (including clear)
All glass dimensions are approximate – handblown glass dimensions vary by nature and intent
Handblown in the Czech Republic

available in transparent colors:



LT216 --- float 16 light dark oxidized
LT216 --- B float 16 light brushed brass
LT220 --- float 20 light dark oxidized
LT220 --- B float 20 light brushed brass

16" Dia (41cm)
16" Dia (41cm)
20" Dia (51cm)
20" Dia (51cm)

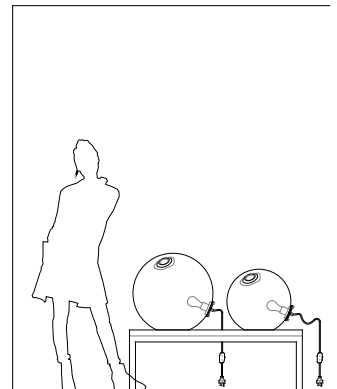

float 20 pendant



float 20 pendants shown with smoke and clear glass, brushed brass metal finish and black fabric-wrapped cords

float 20 pendant

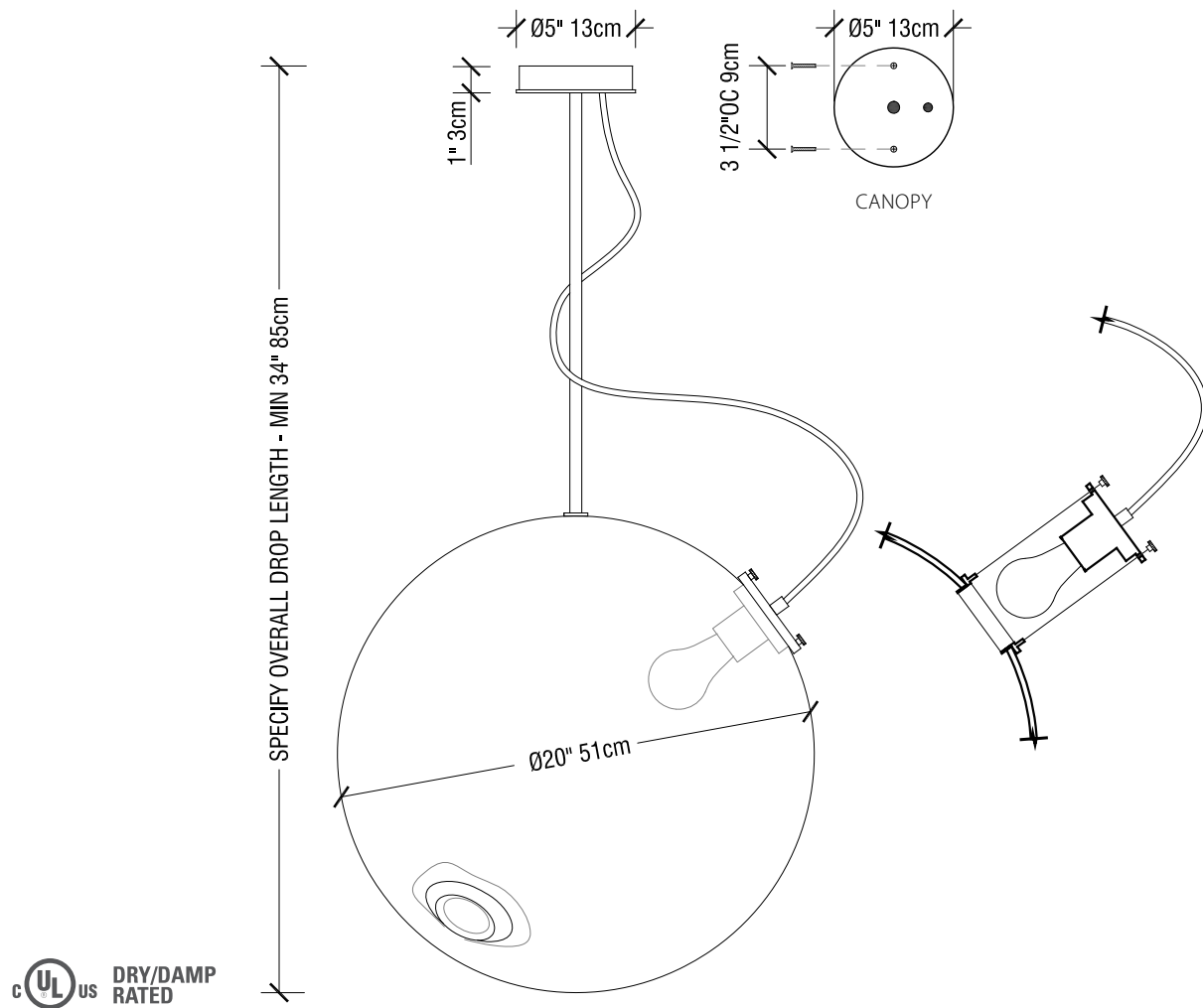

A large sphere of handblown Czech glass with a removable brass socket assembly through the glass. An exposed fabric-wrapped electrical cord runs from the brass socket assembly to the canopy. Each sphere is broken hot from the blower's pipe and then the mouth is torch-polished to create a unique detail – handblown, no two exactly alike. The mouth is located slightly off center, not at the bottom of the sphere, giving the light an organic irregular quality. Two thumb screws attach the removable socket from the side of the glass sphere to access the bulb.

UL LISTED SUITABLE FOR DAMP LOCATIONS (US & CANADA)

Socket: 120V E26 60W Max

Canopy: Brass canopy with exposed fasteners. Recessed steel electrical box required for installation

Pendant suspended from canopy on rigid brass stem (not field adjustable)

Specify overall drop length

Minimum overall drop length is 34" (85cm). Lengths over 58" (147cm) available at additional cost

Specify fabric-wrapped electrical cord color: black, blue, gold, or gray

Bulb included

Standard metal finishes: dark oxidized / brushed brass (other finishes available on request)

Three glass colors available (including clear)

Four fabric-wrapped electrical cord colors available

All glass dimensions are approximate – handblown glass dimensions vary by nature and intent

Handblown in the Czech Republic

available in transparent colors:



clear-CLR



amber-AMB



smoke-SMK

LT320 --- float 20 pendant dark oxidized

LT320 --- B float 20 pendant brushed brass

20" Dia (51 cm) glass

20" Dia (51 cm) glass

cord colors available



black blue gold gray

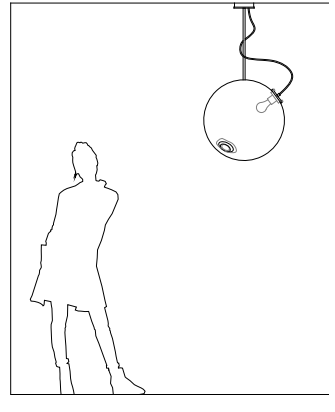

hold 18 *sconce*



hardwired hold 18 sconce shown with opaque white glass and dark oxidized metal finish



transparent colors, from left: clear, olivin, smoke

opaque colors, from left: gray, new blue, white

hold 18 sconce

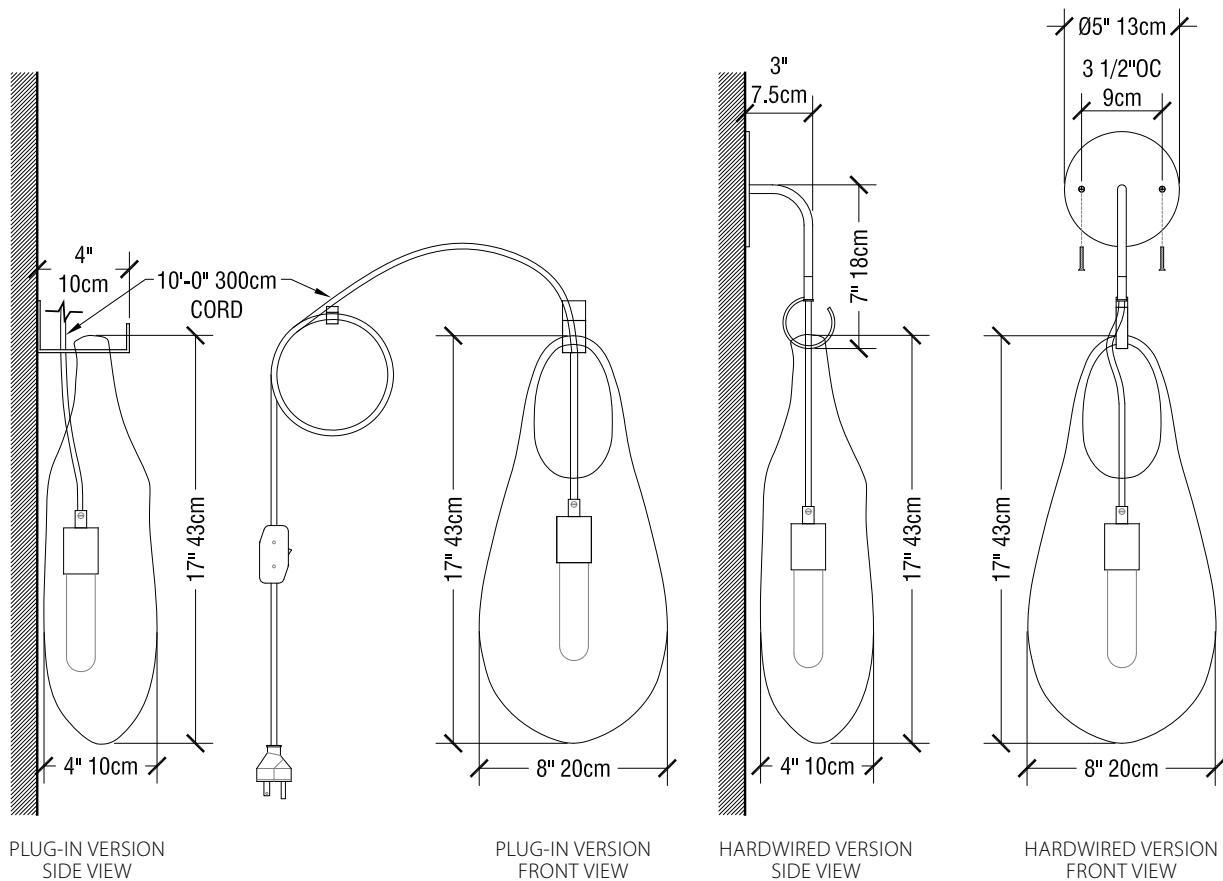

The SkLO *hold* vessel, an expressive glass vessel which appears to droop from its hook as if molten, serves as a diffuser on this wall sconce. Available in two different versions: Plug-in and Hardwired. On the plug-in version, the black fabric-wrapped cord passes through a hole in the steel wall hook, the socket and bulb hang inside the glass vessel. Plug-in version comes with the additional mini hook to wrap the extra cord around (as shown). Handblown, no two exactly alike.

Socket: 120V E26 60W Max

Hardwired version:

Canopy: Brass canopy with exposed fasteners. Recessed steel electrical box required for installation

Plug-In version:

(note: Plug-In Version NOT UL listed)

10 ft (300cm) black fabric-wrapped cord with in-line switch (plug-in version only)

Specify fabric-wrapped electrical cord color: black, blue, gold, or gray

Bulb included

Standard metal finishes: dark oxidized / brushed brass (other finishes available on request)

Six glass colors available (including clear)

Four fabric-wrapped electrical cord colors available

All glass dimensions are approximate – handblown glass dimensions vary by nature and intent

Handblown in the Czech Republic

available in transparent colors: clear-CLR olivin-OLV smoke-SMK

available in opaque colors: gray-GRY new blue-NBL white-WHT

LT260 ---	hold 18 sconce plug-in <i>dark oxidized</i>	glass dimensions	17"H x 8"W x 4"D (43x20x10cm)
LT260 --- B	hold 18 sconce plug-in <i>brushed brass</i>	glass dimensions	17"H x 8"W x 4"D (43x20x10cm)
LT261 ---	hold 18 sconce hardwired <i>dark oxidized</i>	glass dimensions	17"H x 8"W x 4"D (43x20x10cm)
LT261 --- B	hold 18 sconce hardwired <i>brushed brass</i>	glass dimensions	17"H x 8"W x 4"D (43x20x10cm)

cord colors available

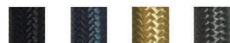

black blue gold gray

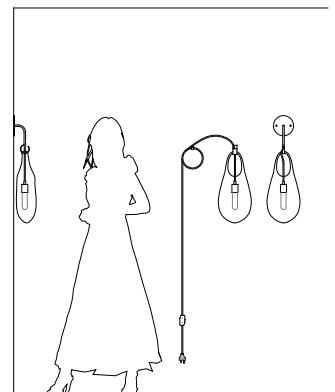

hold 12 *sconce*



hardwired hold 12 sconce shown with opaque white glass and brushed brass metal finish

hold 12 sconce

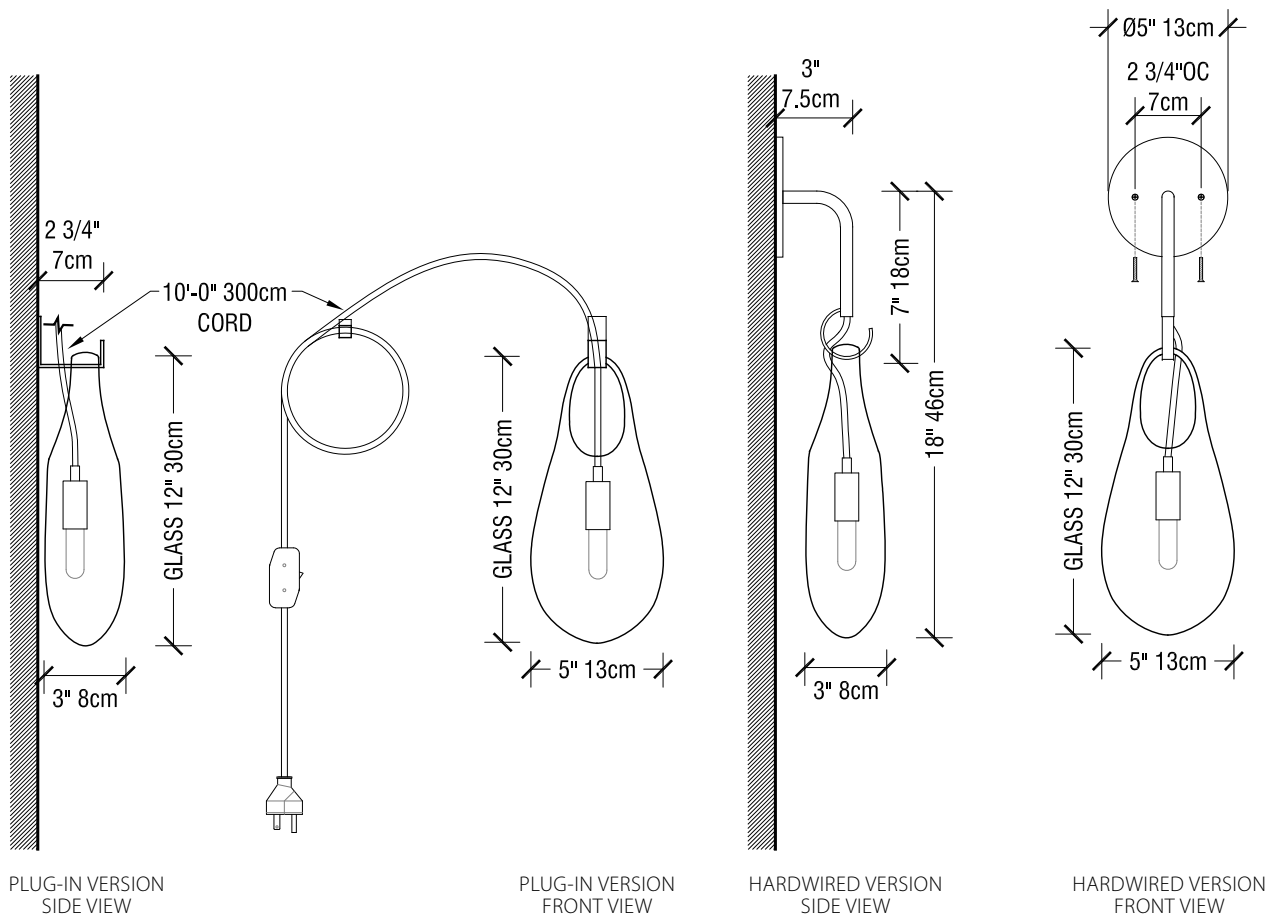

A smaller version of the SkLO *hold*, an expressive glass vessel which appears to droop from its hook as if molten, serves as a diffuser on this wall sconce. Available in two different versions: Plug-in and Hardwired. On the plug-in version, the black fabric-wrapped cord passes through a hole in the steel wall hook, the socket and bulb hang inside the glass vessel. Plug-in version comes with the additional mini hook to wrap the extra cord around (as shown). Handblown, no two exactly alike.

Socket: 120V E12 (Candelabra) 7W Max

Hardwired version:

Canopy: Brass canopy with exposed fasteners. Recessed steel electrical box required for installation

Plug-In version:

(note: Plug-In Version NOT UL listed)

10 ft (300cm) black fabric-wrapped cord with in-line switch (plug-in version only)

Specify fabric-wrapped electrical cord color: black, blue, gold, or gray

Bulb included

Standard metal finishes: dark oxidized / brushed brass (other finishes available on request)

Two glass colors available (including clear)

Four fabric-wrapped electrical cord colors available

All glass dimensions are approximate – handblown glass dimensions vary by nature and intent

Handblown in the Czech Republic

glass colors: clear-CLR white-WHT

LT266 ---	hold 12 sconce plug-in dark oxidized	glass dimensions	12"H x 5"W x 3"D (30x13x8cm)
LT266 --- B	hold 12 sconce plug-in brushed brass	glass dimensions	12"H x 5"W x 3"D (30x13x8cm)
LT267 ---	hold 12 sconce hardwired dark oxidized	glass dimensions	12"H x 5"W x 3"D (30x13x8cm)
LT267 --- B	hold 12 sconce hardwired brushed brass	glass dimensions	12"H x 5"W x 3"D (30x13x8cm)

cord colors available

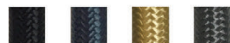

black blue gold gray

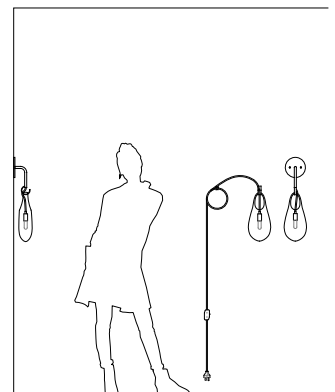

hold 18 *pendant*



hold 18 pendant shown with opaque white glass, brushed brass metal finish and gray fabric-wrapped cord



transparent colors, from left: clear, olivin, smoke

opaque colors, from left: gray, new blue, white

hold 18 pendant

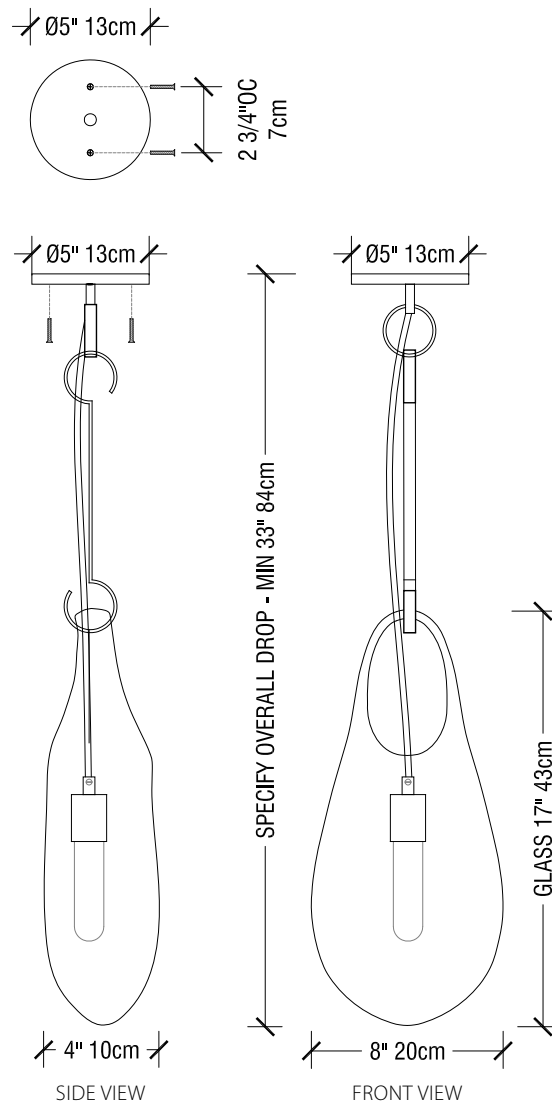

Both a pendant light and a perfect expression of handblown glass. Using the compelling *hold* vessel as a diffuser, the *hold 18* pendant hangs on a double-ended solid brass hook which in turn hangs from a simple solid brass loop at the canopy. The socket is housed in a brass candle cup, hung independently on its own exposed fabric-wrapped electrical cord, suspending the bulb within the glass diffuser. Handblown glass, no two exactly alike.

Socket: 120V E26 60W Max
 Canopy: Brass canopy with exposed fasteners. Recessed steel electrical box required for installation
 Specify overall drop length
 Minimum overall drop length is 33" (84cm). Lengths over 48" (122cm) available at additional cost
 Specify fabric-wrapped electrical cord color: black, blue, gold, or gray
 Bulb included

Two metal finishes available: dark oxidized / brushed brass (other finishes available on request)
 Six glass colors available (including clear)
 Four fabric-wrapped electrical cord colors available
 All glass dimensions are approximate – handblown glass dimensions vary by nature and intent
 Handblown in the Czech Republic

available in transparent colors: clear-CLR olivin-OLV smoke-SMK
 available in opaque colors: gray-GRY new blue-NBL white-WHT

LT262 --- hold 18 pendant dark oxidized
LT262 --- B hold 18 pendant brushed brass

glass dimensions 17"H x 8"W x 4"D (43x20x10cm)
glass dimensions 17"H x 8"W x 4"D (43x20x10cm)

cord colors available



black blue gold gray

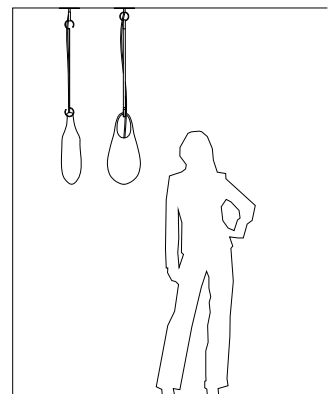

hold 12 *pendant*



hold 12 pendant shown with opaque white glass, brushed brass metal finish and black fabric-wrapped cord

hold 12 pendant

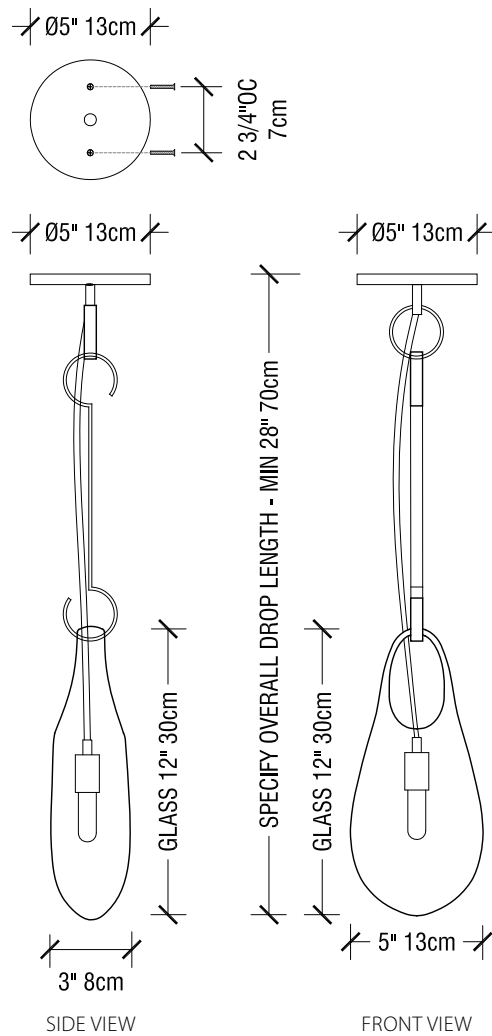

Both a pendant light and a perfect expression of handblown glass. Using a smaller version of the compelling *hold* vessel as a diffuser, the *hold 12* pendant hangs on a double-ended solid brass hook which in turn hangs from a simple solid brass loop at the canopy. The socket is housed in a brass candle cup, hung independently on its own exposed fabric-wrapped electrical cord, suspending the bulb within the glass diffuser. Hand blown glass, no two exactly alike.

Socket: 120V E12 (Candelabra) 7W Max
 Canopy: Brass canopy with exposed fasteners. Recessed steel electrical box required for installation
 Specify overall drop length
 Minimum overall drop length is 28" (70cm). Lengths over 42" (107cm) available at additional cost
 Specify fabric-wrapped electrical cord color: black, blue, gold, or gray
 Bulb included

Two metal finishes available: dark oxidized / brushed brass (other finishes available on request)
 Two glass colors available (including clear)
 Four fabric-wrapped electrical cord colors available
 All glass dimensions are approximate – handblown glass dimensions vary by nature and intent
 Handblown in the Czech Republic

glass colors: clear-CLR white-WHT

LT265 --- hold 12 pendant dark oxidized
 LT265 --- B hold 12 pendant brushed brass

glass dimensions 12"H x 5"W x 3"D (30x13x8cm)
 glass dimensions 12"H x 5"W x 3"D (30x13x8cm)

cord colors available

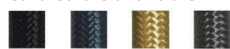

black blue gold gray

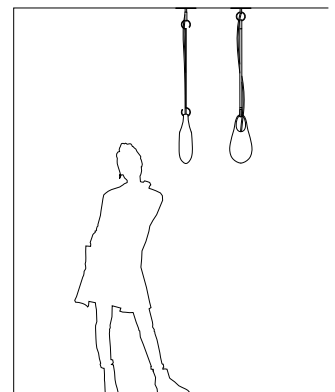

hold pin *pendant*



hold pin pendant shown with stem extension, opaque white glass, brushed brass metal finish and black fabric-wrapped cord

hold pin pendant

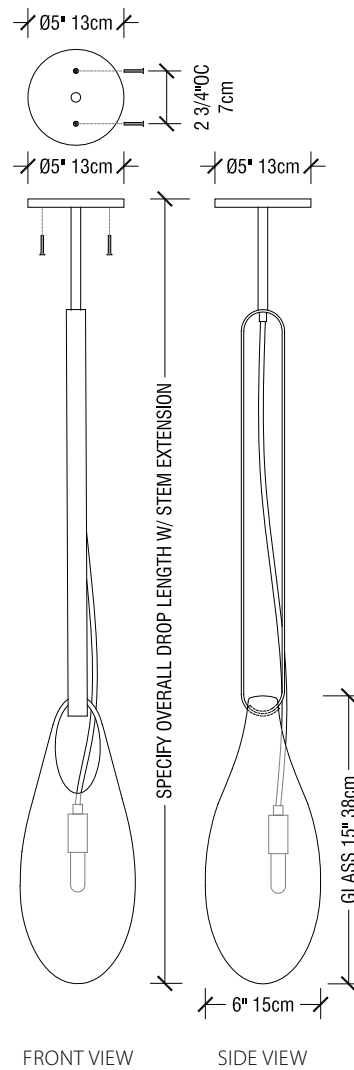
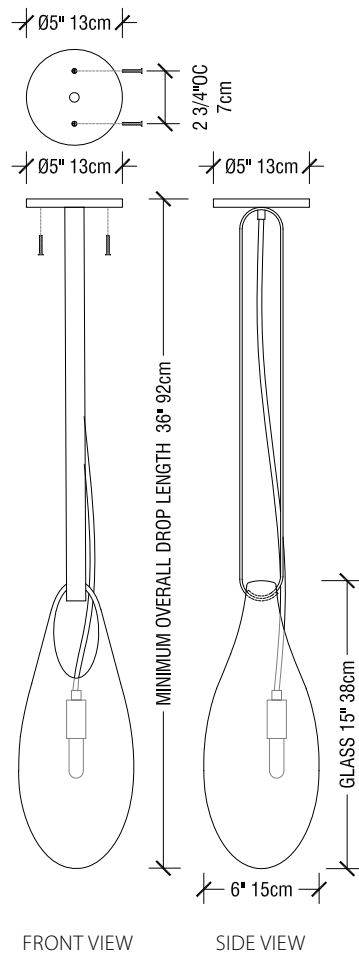

A round version of the SkLO *hold* vessel is suspended from a brass "pin", made of a continuously curved brass bar. The "pin" overlaps at the bottom, allowing for removal of the glass element. The socket is housed in a brass cup, hung independently on its own exposed fabric-wrapped electrical cord, suspending the bulb within the glass diffuser. Handblown glass, no two exactly alike.

Socket: 120V E12 (Candelabra) 7W Max

Canopy: Brass canopy with exposed fasteners. Recessed steel electrical box required for installation

Specify overall drop length

Minimum overall drop length is 36"/92cm (no stem extension). Lengths over 72"/183cm available at additional cost

Specify fabric-wrapped electrical cord color: black, blue, gold, or gray

Bulb included

Standard metal finishes available: dark oxidized / brushed brass (other finishes available on request)

Glass available in opaque white only

Four fabric-wrapped electrical cord colors available

All glass dimensions are approximate – handblown glass dimensions vary by nature and intent

Handblown in the Czech Republic

glass colors: clear-CLR white-WHT

LT365 --- hold pin pendant dark oxidized
 LT365 --- B hold pin pendant brushed brass

glass dimensions 15"H x 6"Dia (38x15cm)
 glass dimensions 15"H x 6"Dia (38x15cm)

cord colors available



black blue gold gray

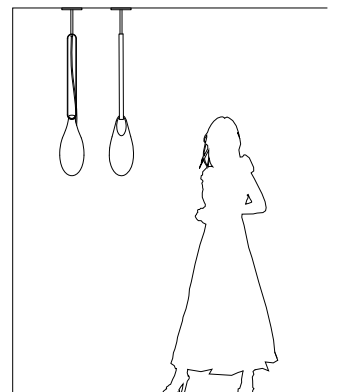

kin *light*



large and small kin light shown with brushed brass metal finish

kin light

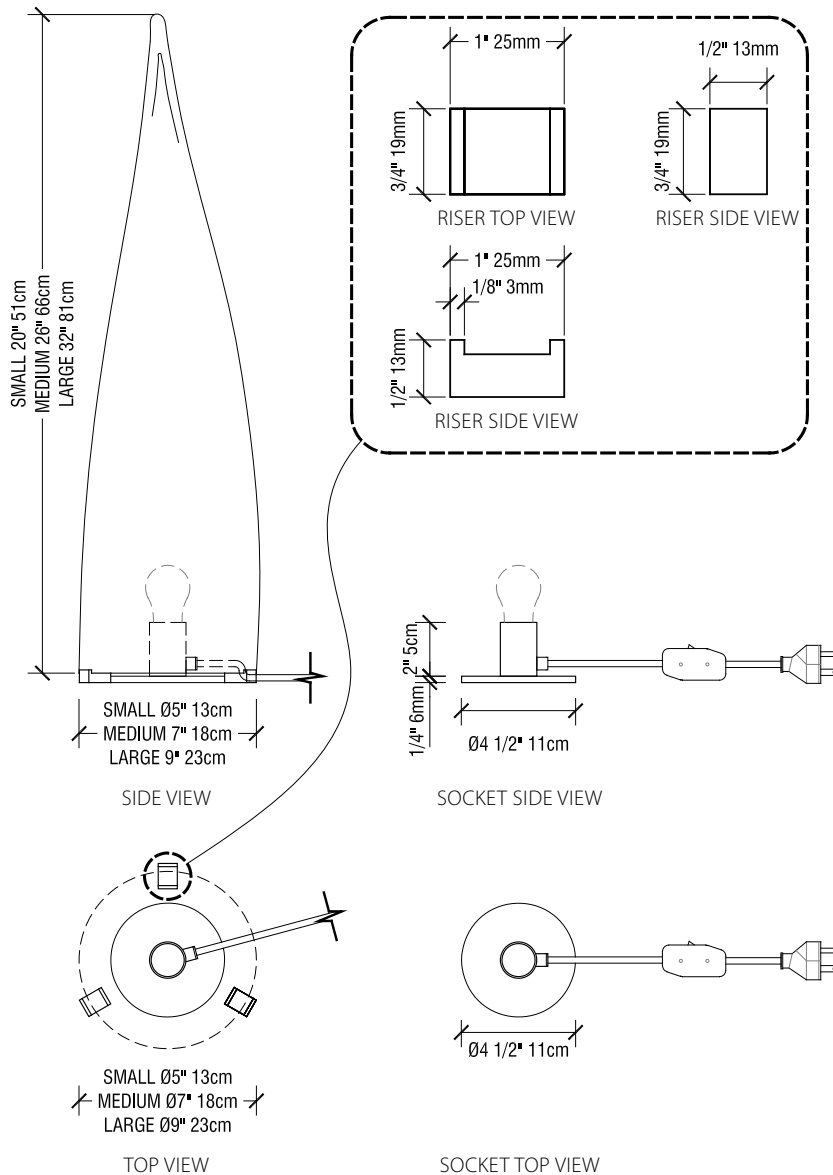

The SkLO *kin* light combines a large conical piece of handblown glass as a diffuser with a separate brass socket. The glass has an opaque color at the base which fades to clear at the top. Glass is available in three sizes. The polished bottom edge of the glass rests atop three loose solid brass risers (to be arranged evenly around the circumference of the base of the glass as shown) to allow the cord from the light socket to pass beneath the glass.

Socket: 120V E26 60W Max

6 ft (180cm) black fabric-wrapped cord with in-line switch

Bulb included

Standard metal finishes: dark oxidized / brushed brass (other finishes available on request)

Glass available in white only

All glass dimensions are approximate – handblown glass dimensions vary by nature and intent

Handblown in the Czech Republic

LT320WHT	kin light small <i>white</i> dark oxidized	20"H x 5"Dia (51x13cm)
LT320WHTB	kin light small <i>white</i> brushed brass	20"H x 5"Dia (51x13cm)
LT321WHT	kin light medium <i>white</i> dark oxidized	26"H x 7"Dia (66x18cm)
LT321WHTB	kin light medium <i>white</i> brushed brass	26"H x 7"Dia (66x18cm)
LT322WHT	kin light large <i>white</i> dark oxidized	32"H x 9"Dia (81x23cm)
LT322WHTB	kin light large <i>white</i> brushed brass	32"H x 9"Dia (81x23cm)

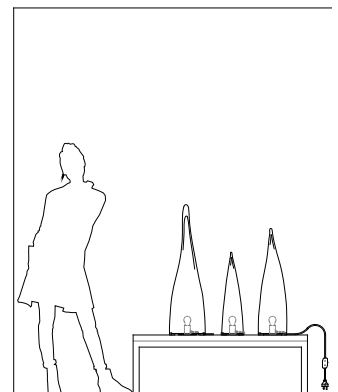

lasso double *pendant*



lasso double pendant shown with clear glass and brushed brass metal finish

lasso double *pendant*

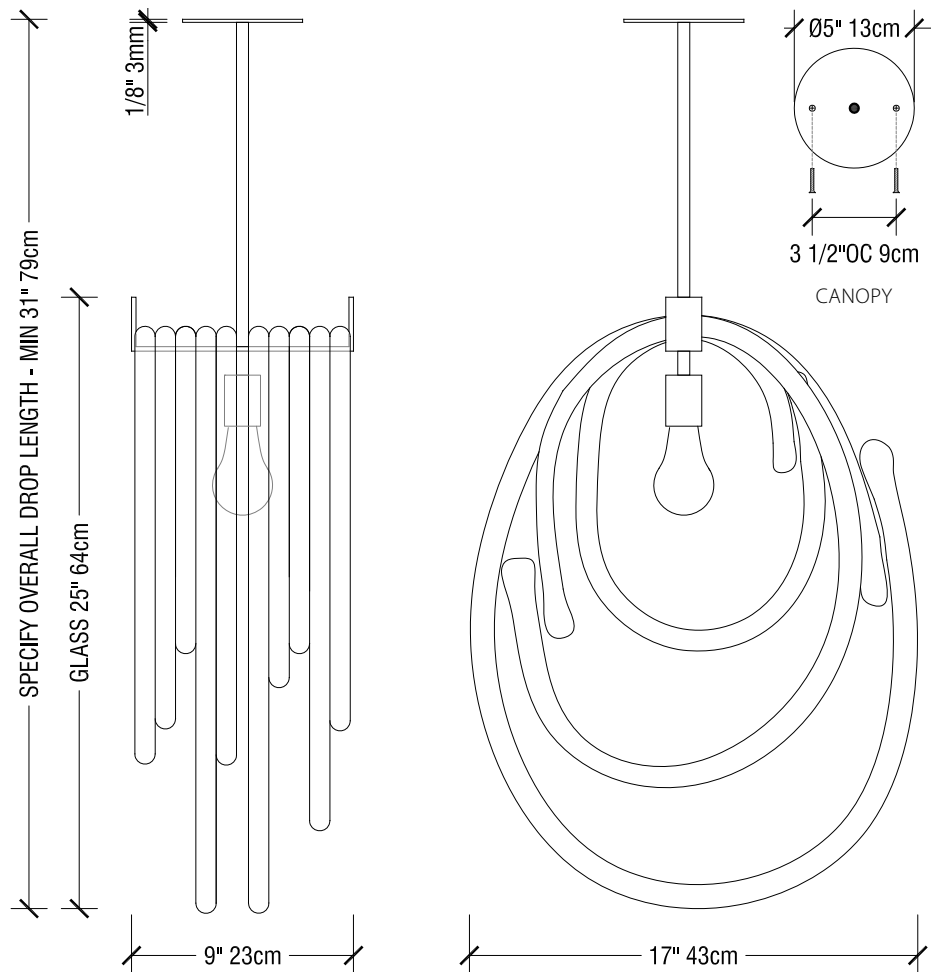

SKLO *lassos* – solid loops of handblown Czech glass – serve here as the shade and diffuser for this unique pendant light fixture. The glass loops come in different sizes, showcasing the amazing depth and clarity of Czech glass. Every loop is unique, an expression of the hand of the glassmaster – no two exactly alike.

UL LISTED SUITABLE FOR DAMP LOCATIONS (US & CANADA)

Socket: 120V E26 60W Max

Canopy: Brass canopy with exposed fasteners. Recessed steel electrical box required for installation

Pendant suspended from canopy on rigid brass stem (not field adjustable)

Specify overall drop length

Minimum overall drop length is 31" (79cm). Lengths over 62" (158cm) available at additional cost

Bulb included

Standard metal finishes: dark oxidized / brushed brass (other finishes available on request)

Two glass colors available (including clear)

All glass dimensions are approximate – handblown glass dimensions vary by nature and intent

Handblown in the Czech Republic

glass colors: clear-CLR white-WHT

LT137 --- lasso double *pendant* dark oxidized

glass dimensions 25"H x 17"W x 9"D (64x43x23cm)

LT137 --- B lasso double *pendant* brushed brass

glass dimensions 25"H x 17"W x 9"D (64x43x23cm)

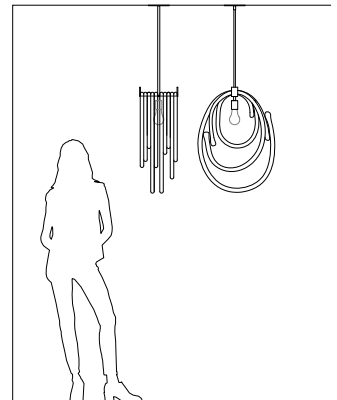

lasso triple *pendant*



lasso triple pendant shown with opaque white glass and dark oxidized metal finish

lasso triple pendant

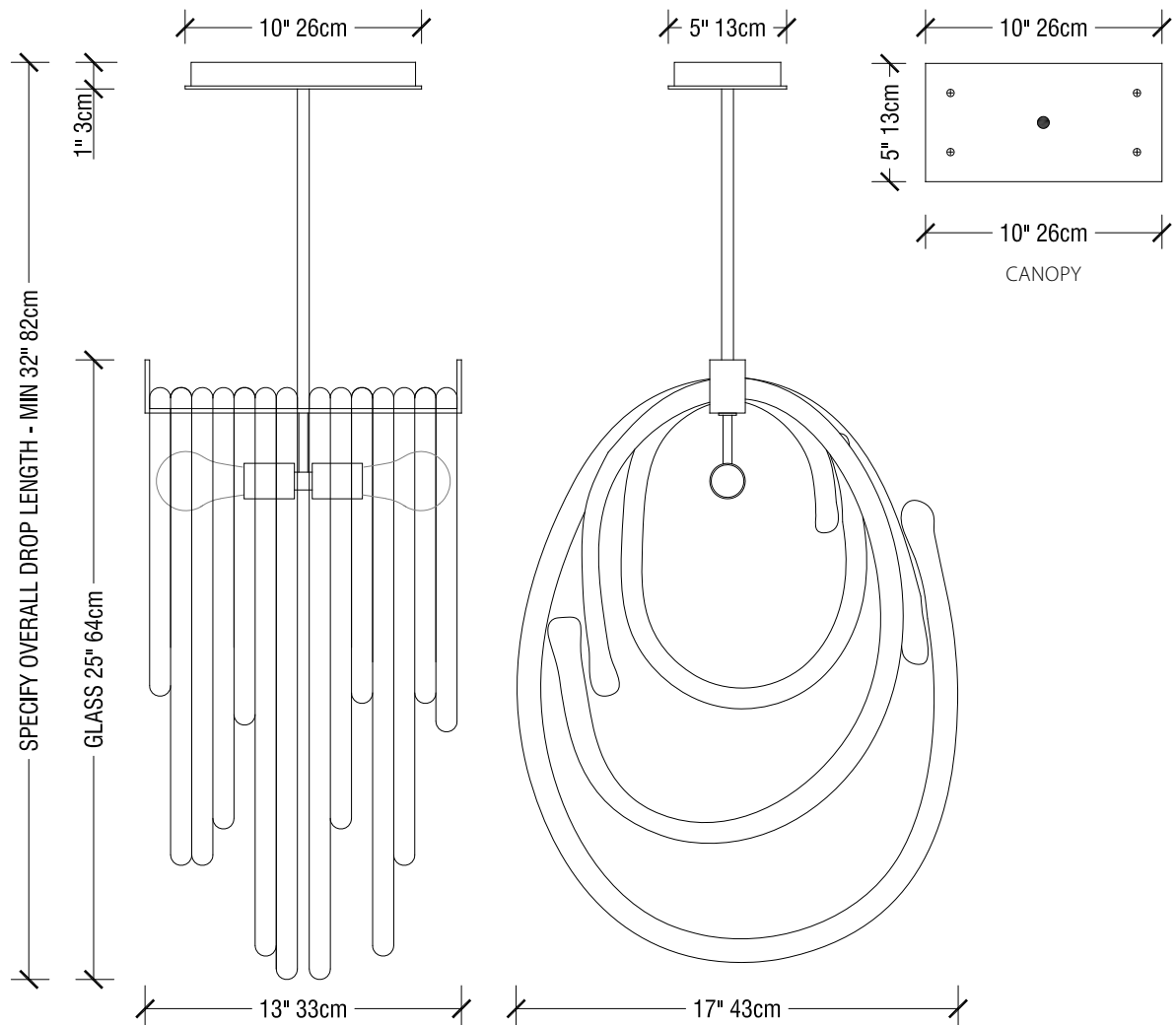

SKLO lassos – solid loops of handblown Czech glass – serve here as the shade and diffuser for this unique pendant light fixture. The glass loops come in different sizes, showcasing the amazing depth and clarity of Czech glass. Every loop is unique, an expression of the hand of the glassmaster – no two exactly alike.

UL LISTED SUITABLE FOR DAMP LOCATIONS (US & CANADA)

Sockets: 120V E26 60W Max

Canopy: Brass canopy with exposed fasteners and steel mounting plate. Recessed electrical box required for installation

Pendant suspended from canopy on rigid brass stem (not field adjustable)

Specify overall drop length

Minimum overall drop length is 32" (82cm). Lengths over 63" (160cm) available at additional cost

Bulbs included

Standard metal finishes: dark oxidized / brushed brass (other finishes available on request)

Two glass colors available (including clear)

All glass dimensions are approximate – handblown glass dimensions vary by nature and intent

Handblown in the Czech Republic

glass colors: clear-CLR white-WHT

LT138 --- lasso triple pendant dark oxidized

glass dimensions 25"H x 17"W x 13"D (64x43x33cm)

LT138 --- B lasso triple pendant brushed brass

glass dimensions 25"H x 17"W x 13"D (64x43x33cm)

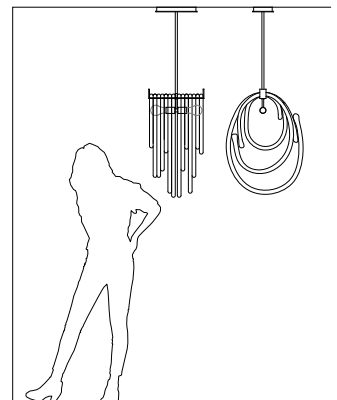

lasso chandelier



lasso 48 chandelier shown with white glass lassos and dark oxidized metal finish

lasso 48 chandelier

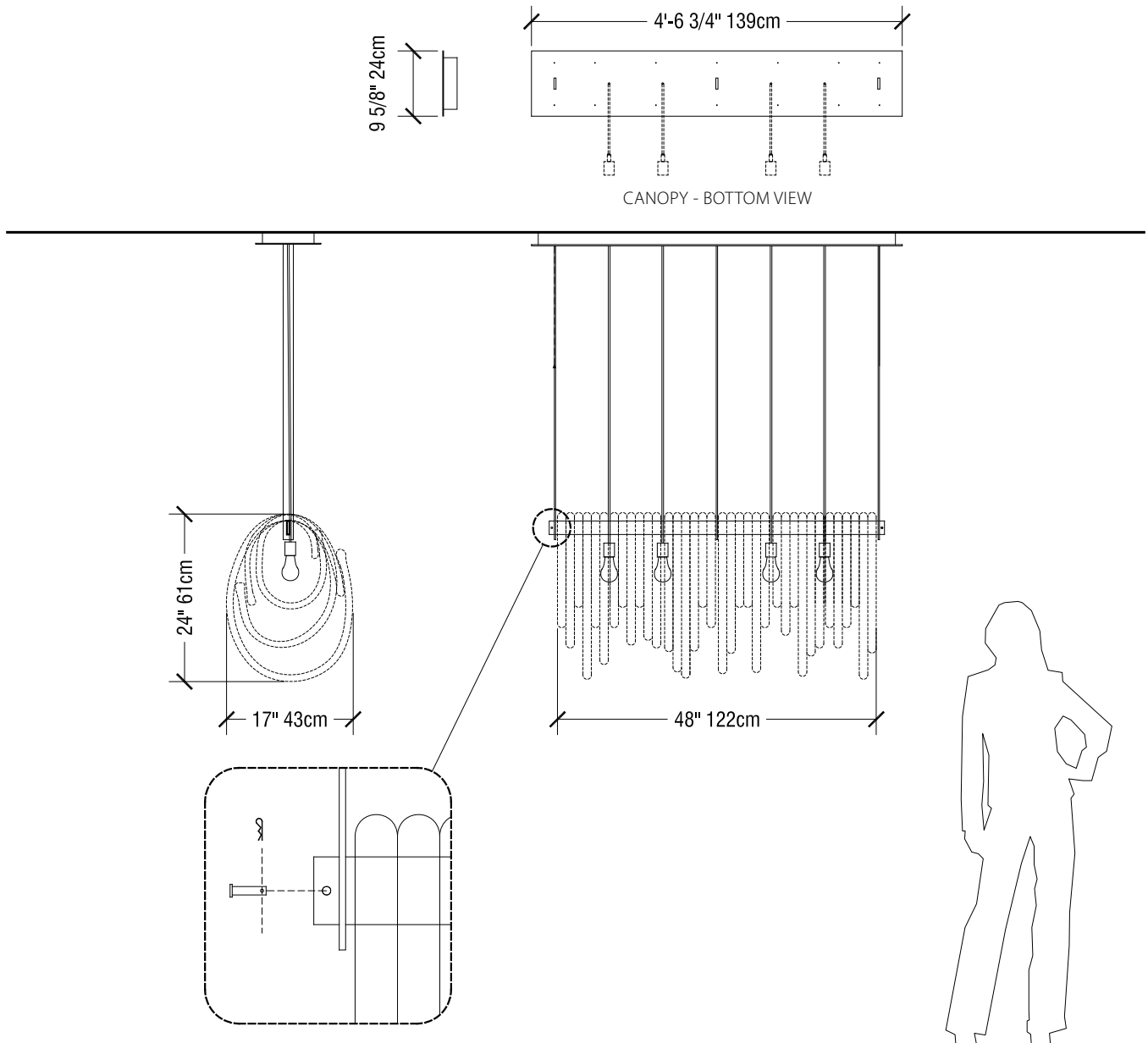

Large, linear handmade steel light fixtures featuring long rows of glass *lassos* – solid loops of handblown Czech glass – of different sizes. All glass *lassos* are handblown in the Czech Republic. SkLO *lasso* chandeliers are available in three lengths: 48", 60" and 72". The 48" chandelier is a four bulb fixture, the 60" chandelier is a six bulb fixture, and the 72" chandelier is an eight bulb fixture. Each socket hangs individually from exposed fabric wrapped electrical cords which are available in a range of standard colors. Note that the SkLO *lassos* are handmade, and therefore exact glass dimensions will vary. This fixture will not accommodate sloped ceilings. All SkLO *lasso* chandeliers are built-to-order. Please allow for a lead time of up to 12 weeks.

UL LISTED SUITABLE FOR DAMP LOCATIONS (US & CANADA)

Sockets: 120V E26 60W Max

Installation requires recessed steel electrical box. Fixture requires mounting direct to adequate structure

Specify drop (distance from finish ceiling to bottom of glass)

Specify fabric-wrapped electrical cord color: black, blue, gold, or gray

Available in dark oxidized and polished nickel metal finish only

Two glass colors available (including clear)

All glass dimensions are approximate – handblown glass dimensions vary by nature and intent

Handblown in the Czech Republic

available in: clear-CLR white-WHT

LT140 --- lasso 48 chandelier dark oxidized

48"L (122cm)

LT140 --- N lasso 48 chandelier polished nickel

48"L (122cm)



lasso 60 chandelier

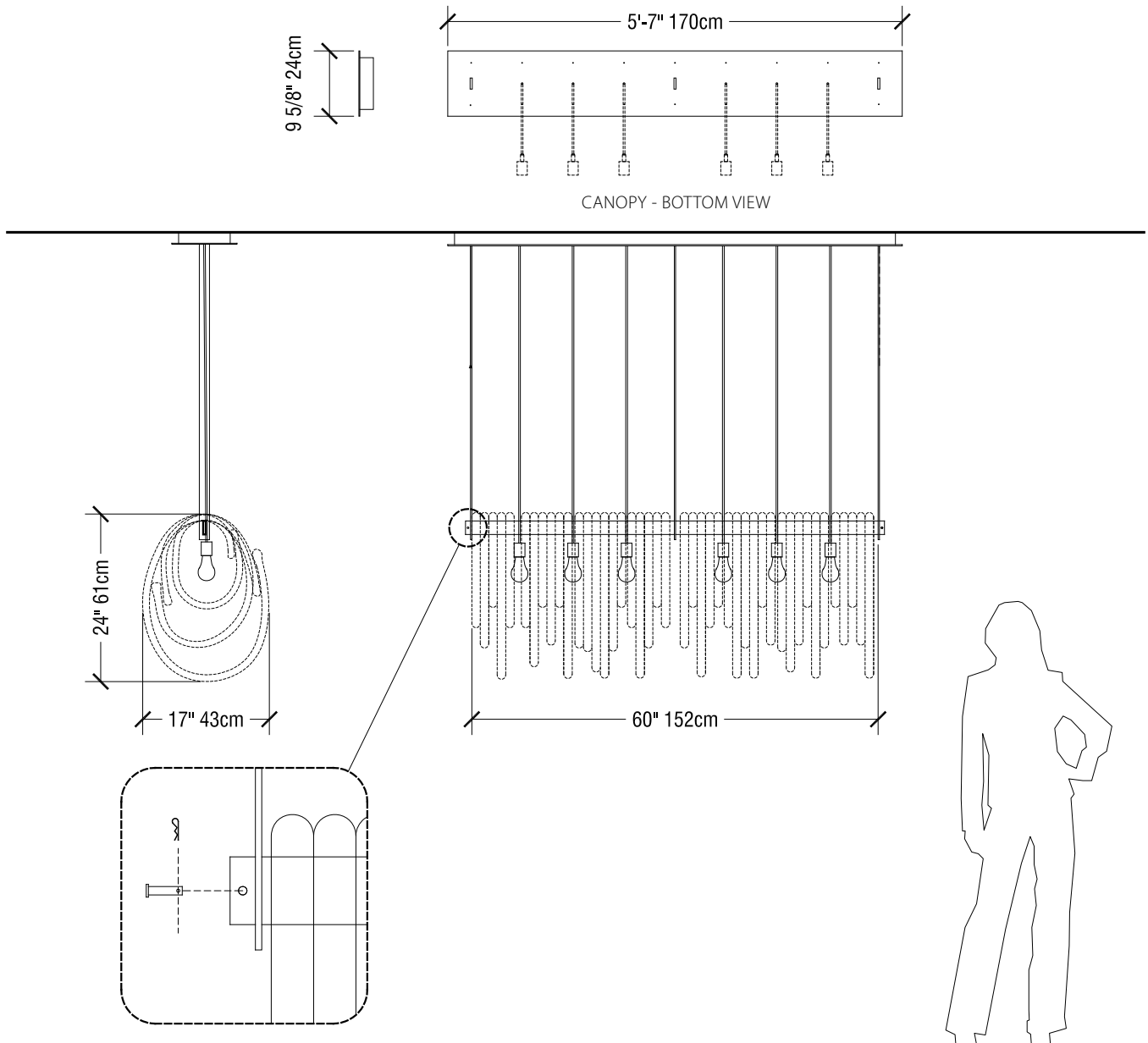

Large, linear handmade steel light fixtures featuring long rows of glass *lassos* – solid loops of handblown Czech glass – of different sizes. All glass *lassos* are handblown in the Czech Republic. SkLO *lasso* chandeliers are available in three lengths: 48", 60" and 72". The 48" chandelier is a four bulb fixture, the 60" chandelier is a six bulb fixture, and the 72" chandelier is an eight bulb fixture. Each socket hangs individually from exposed fabric wrapped electrical cords which are available in a range of standard colors. Note that the SkLO *lassos* are handmade, and therefore exact glass dimensions will vary. This fixture will not accommodate sloped ceilings. All SkLO *lasso* chandeliers are built-to-order. Please allow for a lead time of up to 12 weeks.

UL LISTED SUITABLE FOR DAMP LOCATIONS (US & CANADA)

Sockets: 120V E26 60W Max

Installation requires recessed steel electrical box. Fixture requires mounting direct to adequate structure

Specify drop (distance from finish ceiling to bottom of glass)

Specify fabric-wrapped electrical cord color: black, blue, gold, or gray

Available in dark oxidized and polished nickel metal finish only

Two glass colors available (including clear)

All glass dimensions are approximate – handblown glass dimensions vary by nature and intent

Handblown in the Czech Republic

available in: clear-CLR white-WHT

LT141 --- lasso 60 chandelier dark oxidized

60"L (152cm)

LT141 --- N lasso 60 chandelier polished nickel

60"L (152cm)



lasso 72 chandelier

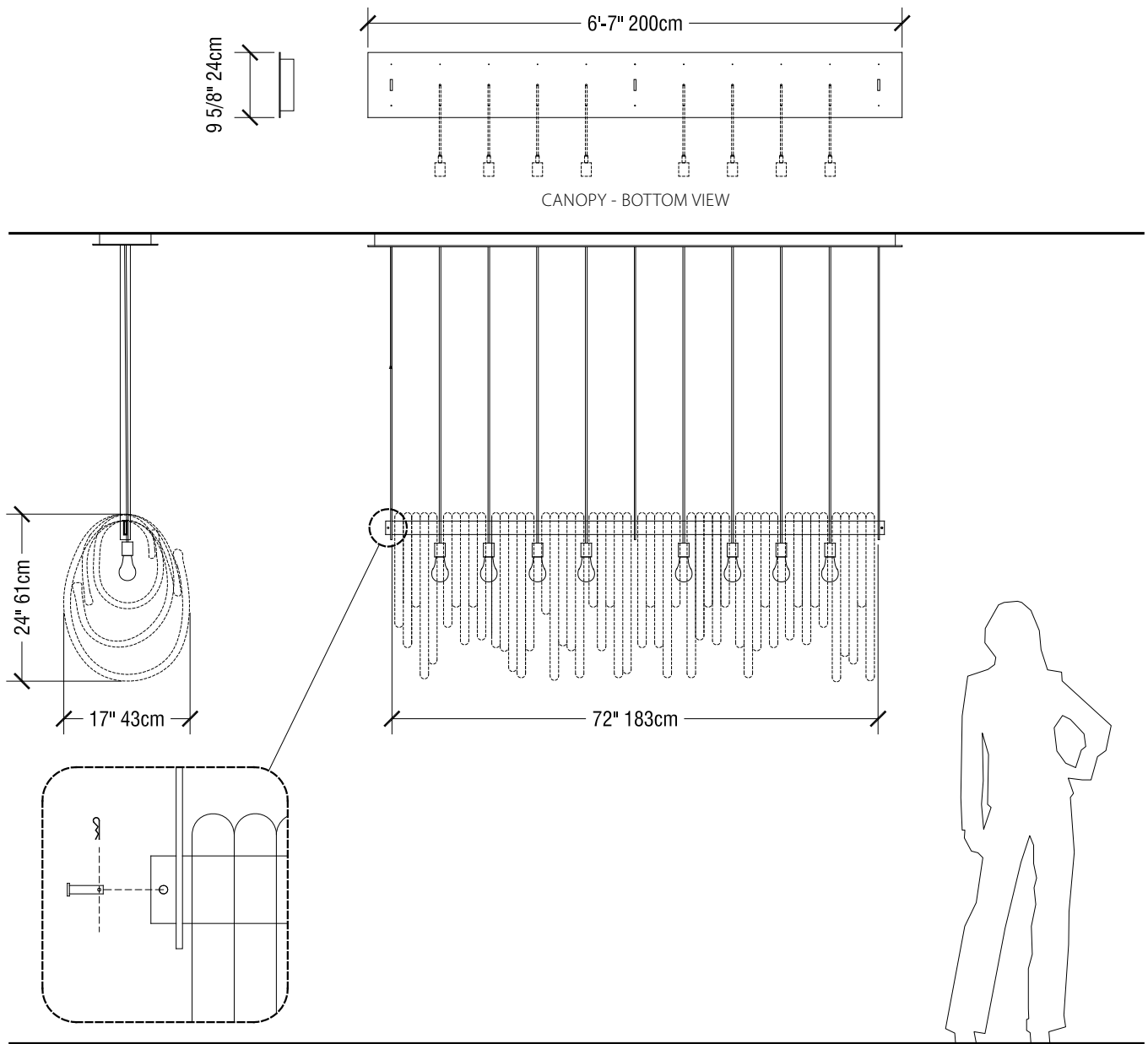

Large, linear handmade steel light fixtures featuring long rows of glass *lassos* – solid loops of handblown Czech glass – of different sizes. All glass *lassos* are handblown in the Czech Republic. SkLO *lasso* chandeliers are available in three lengths: 48", 60" and 72". The 48" chandelier is a four bulb fixture, the 60" chandelier is a six bulb fixture, and the 72" chandelier is an eight bulb fixture. Each socket hangs individually from exposed fabric wrapped electrical cords which are available in a range of standard colors. Note that the SkLO *lassos* are handmade, and therefore exact glass dimensions will vary. This fixture will not accommodate sloped ceilings. All SkLO *lasso* chandeliers are built-to-order. Please allow for a lead time of up to 12 weeks.

UL LISTED SUITABLE FOR DAMP LOCATIONS (US & CANADA)

Sockets: 120V E26 60W Max

Installation requires recessed steel electrical box. Fixture requires mounting direct to adequate structure

Specify drop (distance from finish ceiling to bottom of glass)

Specify fabric-wrapped electrical cord color: black, blue, gold, or gray

Available in dark oxidized and polished nickel metal finish only

Two glass colors available (including clear)

All glass dimensions are approximate – handblown glass dimensions vary by nature and intent

Handblown in the Czech Republic

available in: clear-CLR white-WHT

LT142 --- lasso 72 chandelier dark oxidized

72"L (183cm)

LT142 --- N lasso 72 chandelier polished nickel

72"L (183cm)



once light



*top: once light shown with 10" (25cm) diameter opaque white glass and brushed brass metal finish
bottom: all three sizes of once light with opaque white glass and brushed brass metal finish*

once light

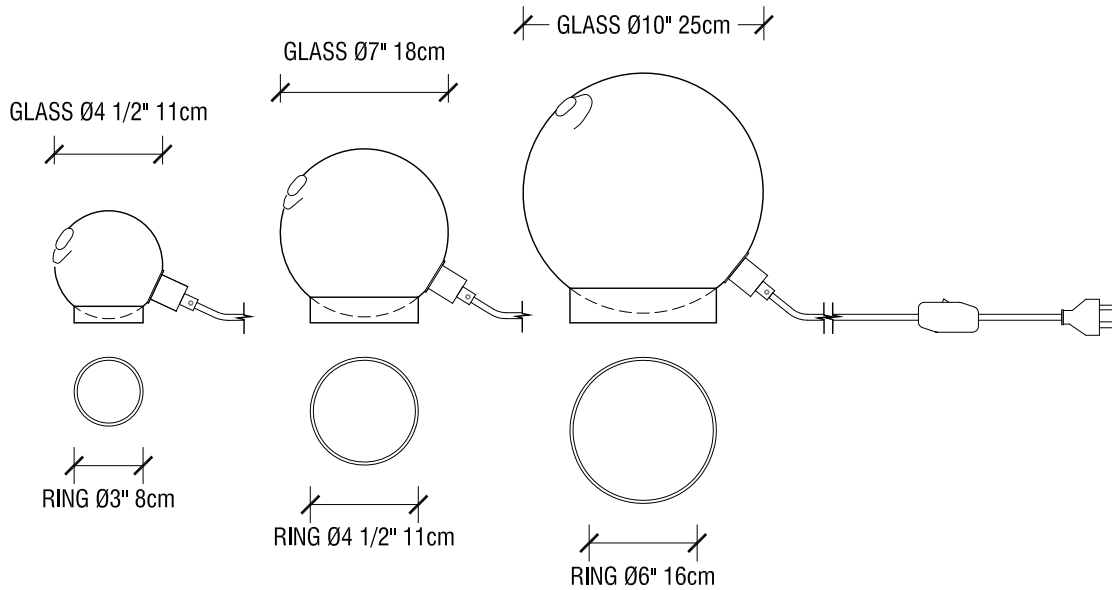

The *once* light consists of a single lit sphere of handblown Czech glass which rests atop a brass ring. Available in three different glass sizes – 4 1/2" (11cm), 7" (18cm) and 10" (25cm) diameter – and five glass colors. The rings are included, and each ring is sized to match the glass size. The glass spheres each feature an off-center double-dipped fire-polished mouth where the piece is broken from the blower's pipe, making each unique.

Socket: 120V E12 (candelabra) 7W Max (G9 sockets available on request)
 6 ft (180cm) black fabric-wrapped cord with in-line switch
 Bulb included

Standard metal finishes: dark oxidized / brushed brass (other finishes available on request)

Five glass colors available (including clear)

All glass dimensions are approximate – handblown glass dimensions vary by nature and intent

Handblown in the Czech Republic

transparent colors:



clear-CLR



olivin-OLV



smoke-SMK

opaque colors:



new blue-NBL



white-WHT

LT165 ---	once light dark oxidized	4.5"Dia (11cm) glass
LT165 --- B	once light brushed brass	4.5"Dia (11cm) glass
LT166 ---	once light dark oxidized	7"Dia (18cm) glass
LT166 --- B	once light brushed brass	7"Dia (18cm) glass
LT167 ---	once light dark oxidized	10"Dia (25cm) glass
LT167 --- B	once light brushed brass	10"Dia (25cm) glass

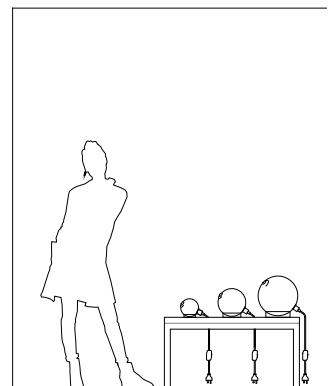

push table



push table light shown with brushed brass hardware – inset shows "push" detail at top of the glass

push table

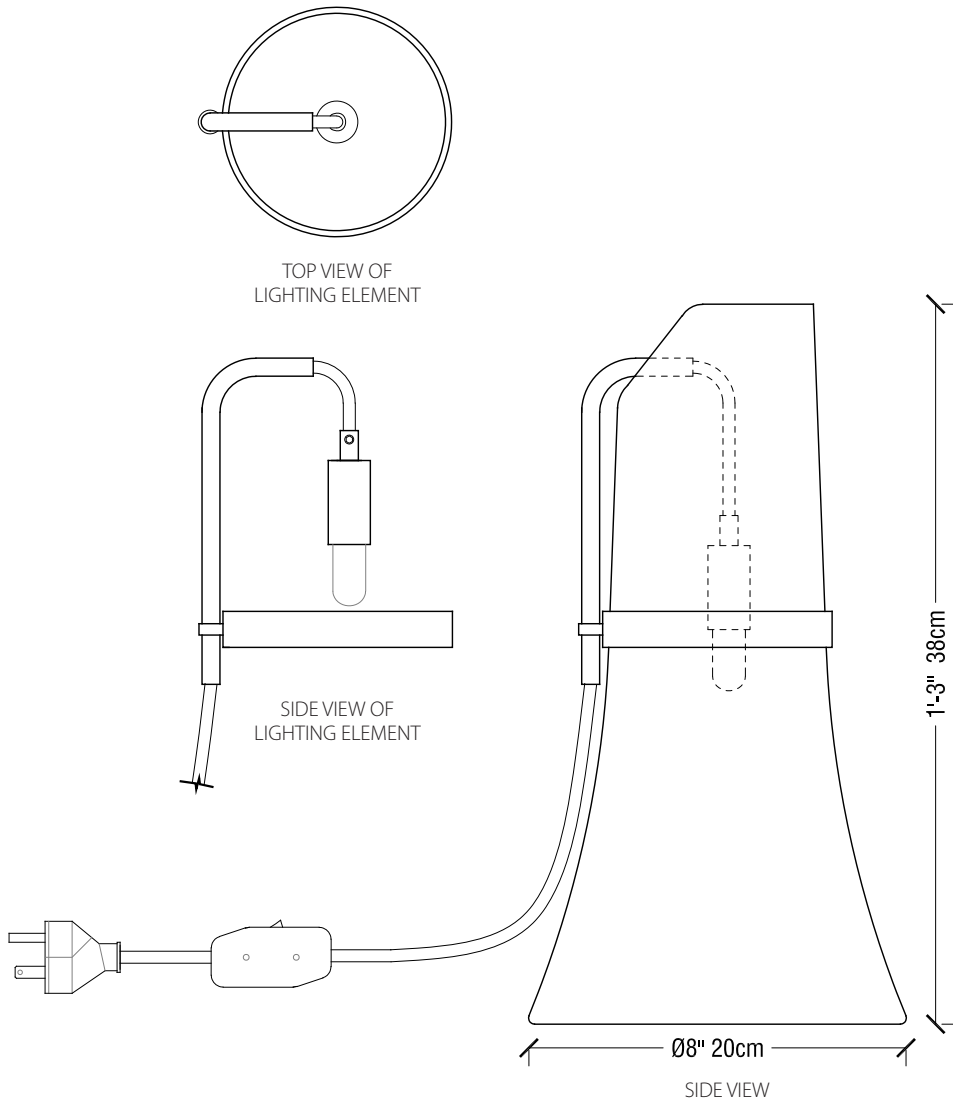

The *push* table light is a minimal, curving, tapered cylinder of handblown opaque white glass, transformed into a compelling table light with the addition of a clever brass armature. A brass ring slides over the top of the glass and supports a brass tube which bends into a depression in the top lip of the glass, produced while hot on the glass blower's pipe. A fabric-wrapped electrical cord suspends a brass socket and light bulb from the tube down within the glass diffuser. The detail in the glass evokes the molten origins of the handblown glass, and the interaction between brass and glass make for a sophisticated light.

Socket: 120V E12 (candelabra) 7W Max
 6 ft (180cm) black fabric-wrapped cord with in-line switch
 Bulb included

Standard metal finishes: dark oxidized / brushed brass (other finishes available on request)
 Glass available in opaque white only
 All glass dimensions are approximate – handblown glass dimensions vary by nature and intent
 Handblown in the Czech Republic

LT720WHT *push table* dark oxidized
LT720WHTB *push table* brushed brass

1'-3"H x 8"Dia (38x20cm)
 1'-3"H x 8"Dia (38x20cm)

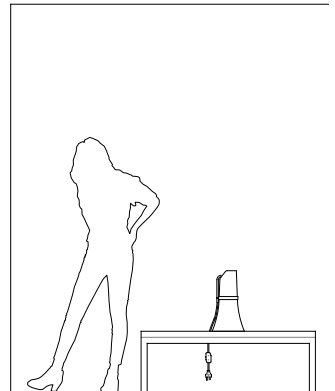

reflect *pendant*



from left: shape 1, shape 2, and shape 3

reflect pendant

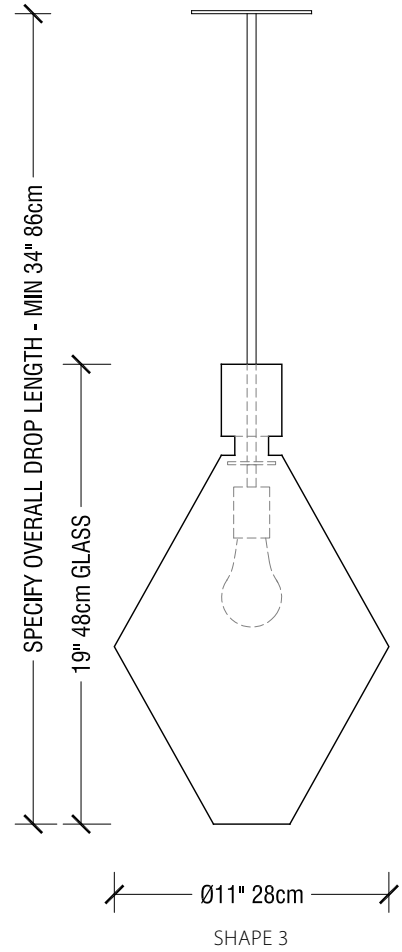
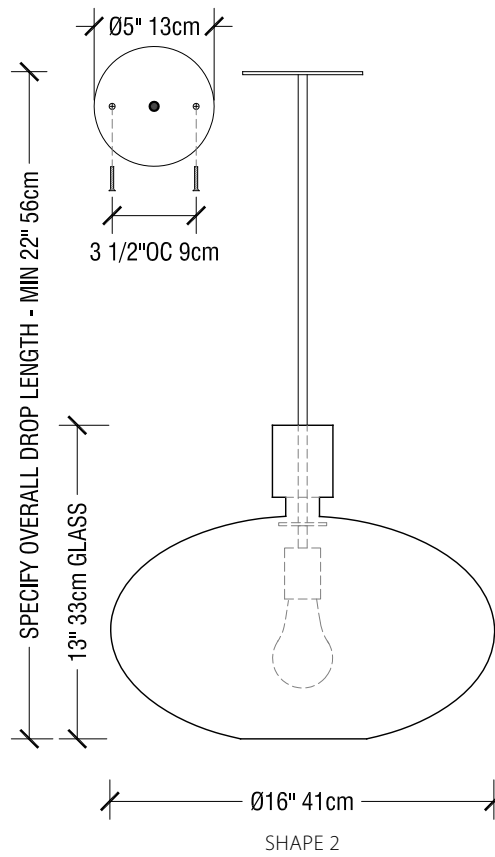
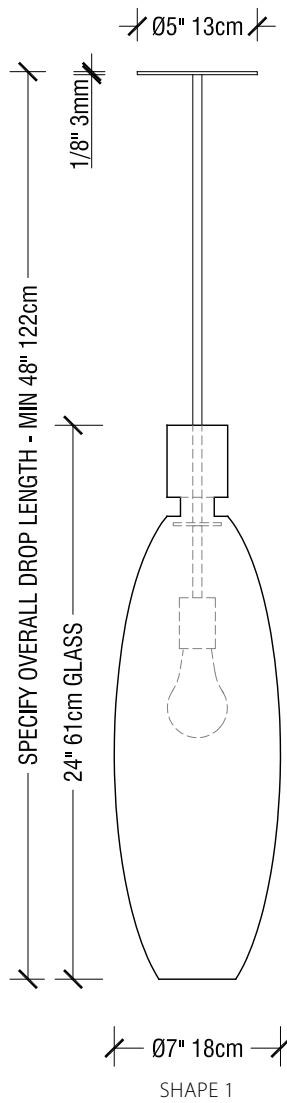

The SkLO *reflect* pendants are a series of mirror plated glass pendants in different geometric shapes. The glass is mirrored using a unique process that produces an opaque mirror appearance when the light is off but allows light to pass through when on. Each shape has an open mouth at the bottom – the holes are ground flat and polished. The mirrored glass shades rest atop a disc at the end of the rigid brass stem – light bulbs are accessed by either reaching through the open hole or by carefully raising the glass up over the bulb.

UL LISTED SUITABLE FOR DAMP LOCATIONS (US & CANADA)

Socket: 120V E26 60W Max

Canopy: Brass canopy with exposed fasteners. Recessed steel electrical box required for installation

Pendant suspended from canopy on rigid brass stem (not field adjustable)

Specify overall drop length, see drawing for minimum lengths

Lengths over 56"/142cm (LT370SLV), 46"/117cm (LT371SLV) and 52"/132cm (LT372SLV) available at additional cost

Bulb included

Available in brushed brass metal finish only

Glass available in silver mirrored finish only

All glass dimensions are approximate – handblown glass dimensions vary by nature and intent

Handblown in the Czech Republic

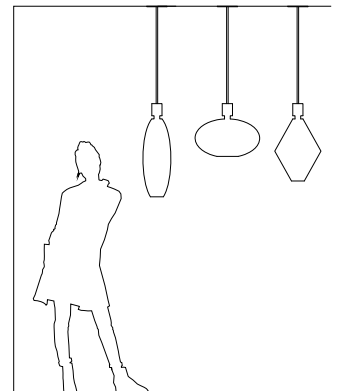

LT370SLV	reflect pendant shape 1	mirrored glass (silver)/brushed brass stem	glass dimensions	24"H x 7"Dia (61x18cm)
LT371SLV	reflect pendant shape 2	mirrored glass (silver)/brushed brass stem	glass dimensions	13"H x 16"Dia (33x41cm)
LT372SLV	reflect pendant shape 3	mirrored glass (silver)/brushed brass stem	glass dimensions	19"H x 11"Dia (48x28cm)



stem *pendant 1x*



stem 1x pendant shown with opaque white glass and brushed brass metal finish

stem pendant 1x

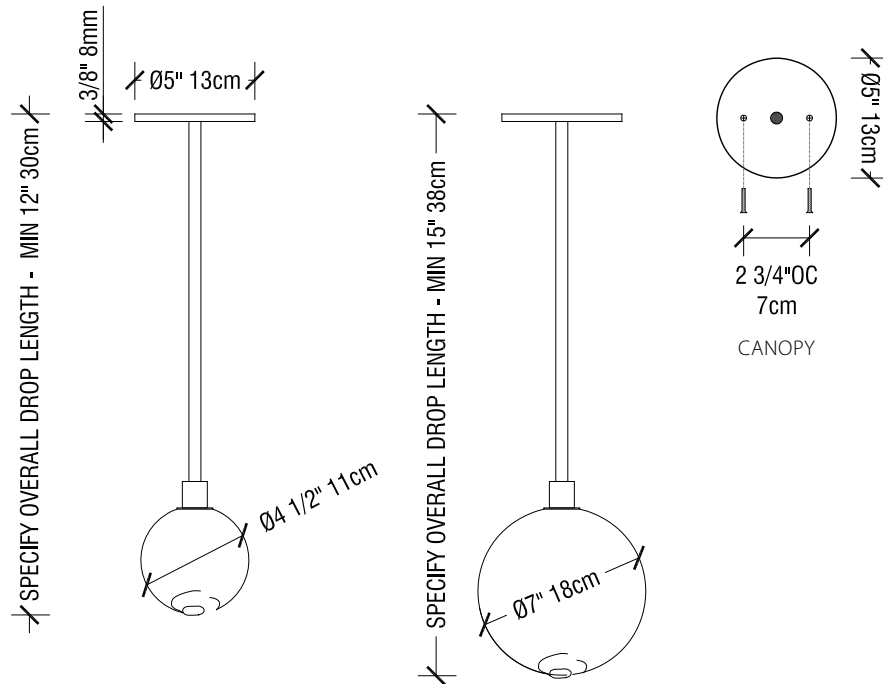

The *stem* 1x pendants are minimal pendants consisting of single lit spheres of handblown Czech glass suspended on a rigid brass stem. Choose from either a small, 4 1/2" (11cm) diameter or a large, 7" (18cm) diameter sphere. Glass is available in five colors. The glass features the signature SkLO double-dipped, fire-polished mouths which show where the glass is broken from the blower's pipe, making each unique.

UL LISTED SUITABLE FOR DAMP LOCATIONS (US & CANADA)

Socket: 120V E12 (candelabra) 7W Max (G9 socket available on request)

Canopy: Brass canopy with exposed fasteners. Recessed steel electrical box required for installation

Pendant suspended from canopy on rigid brass stem – not field adjustable

Specify overall drop length

Minimum overall drop length is 12"/30cm (LT310) and 15"/38cm (LT312). Lengths over 43"/110cm (LT310) and 46"/117cm (LT312) available at additional cost

Bulb included

Standard metal finishes: dark oxidized / brushed brass (other finishes available on request)

Five glass colors available (including clear)

All glass dimensions are approximate – handblown glass dimensions vary by nature and intent

Handblown in the Czech Republic

transparent colors:



clear-CLR



olivin-OLV



smoke-SMK

opaque colors:



new blue-NBL



white-WHT

LT310 --- stem pendant 1x dark oxidized 4.5"Dia (11cm) glass

LT310 --- B stem pendant 1x brushed brass 4.5"Dia (11cm) glass

LT312 --- stem pendant 1x dark oxidized 7"Dia (18cm) glass

LT312 --- B stem pendant 1x brushed brass 7"Dia (18cm) glass

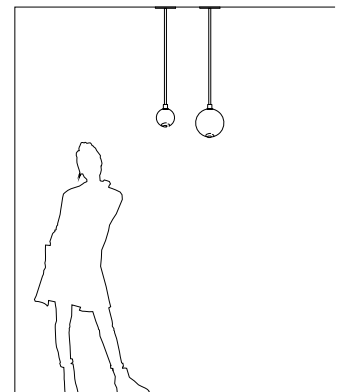

stem *pendant 2x*



stem 2x pendant shown with opaque white glass and brushed brass metal finish

stem pendant 2x

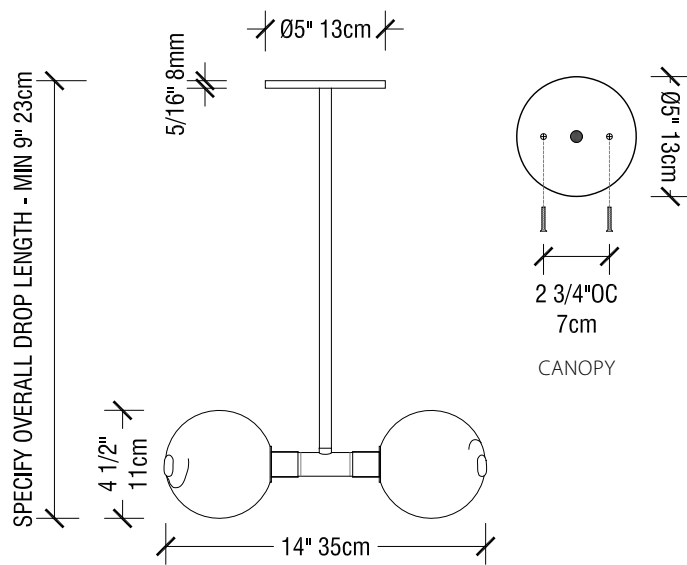

The *stem 2x* pendant is a minimal pendant consisting of a pair of lit spheres of handblown Czech glass suspended on a rigid brass stem. The spheres are 4 1/2" (11cm) in diameter and are available in five glass colors. The glass features the signature SkLO double-dipped, fire-polished mouths which show where the glass is broken from the blower's pipe, making each unique.

UL LISTED SUITABLE FOR DAMP LOCATIONS (US & CANADA)

Sockets: 120V E12 (candelabra) 7W Max (G9 socket available on request)

Canopy: Brass canopy with exposed fasteners. Recessed steel electrical box required for installation

Pendant suspended from canopy on rigid brass stem – not field adjustable

Specify overall drop length

Minimum overall drop length is 9" (23cm). Lengths over 40" (102cm) available at additional cost

Bulbs included

Standard metal finishes: dark oxidized / brushed brass (other finishes available on request)

Five glass colors available (including clear)

All glass dimensions are approximate – handblown glass dimensions vary by nature and intent

Handblown in the Czech Republic

transparent colors:



clear-CLR



olivin-OLV



smoke-SMK

opaque colors:



new blue-NBL



white-WHT

LT311 --- stem pendant 2x dark oxidized 4.5"Dia (11cm) glass 14"W (35cm)

LT311 --- B stem pendant 2x brushed brass 4.5"Dia (11cm) glass 14"W (35cm)

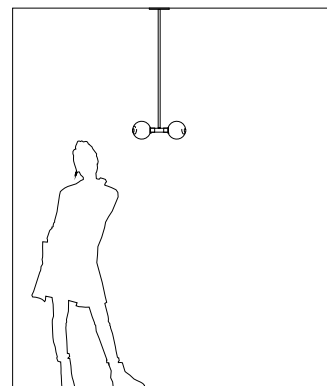

stem *pendant* **3x**



stem 3x pendant shown with 7" (18cm) opaque white glass and brushed brass metal finish

stem pendant 3x

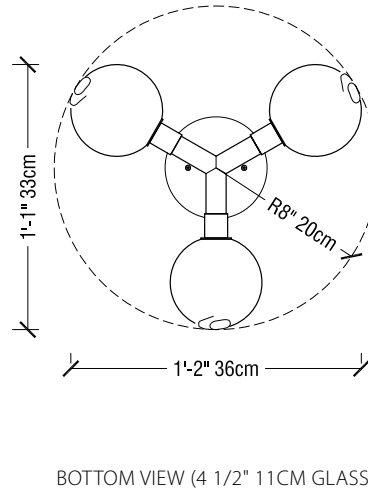
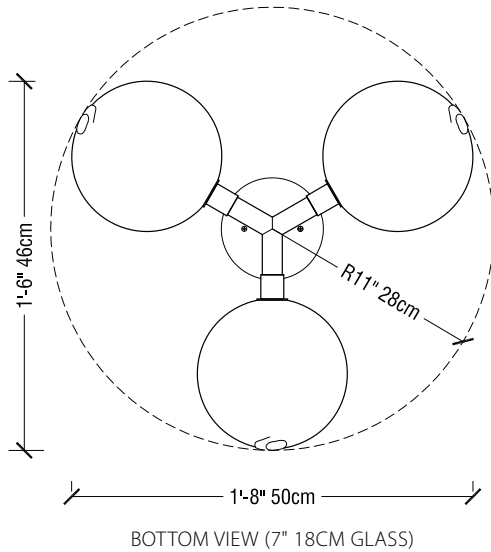
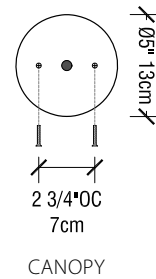
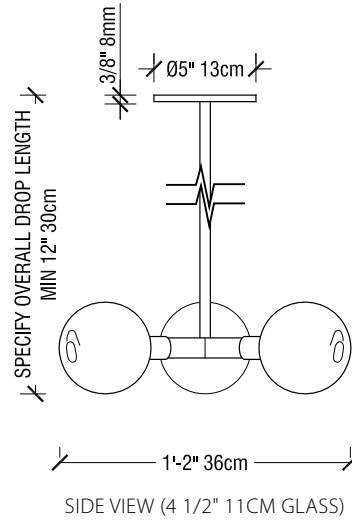
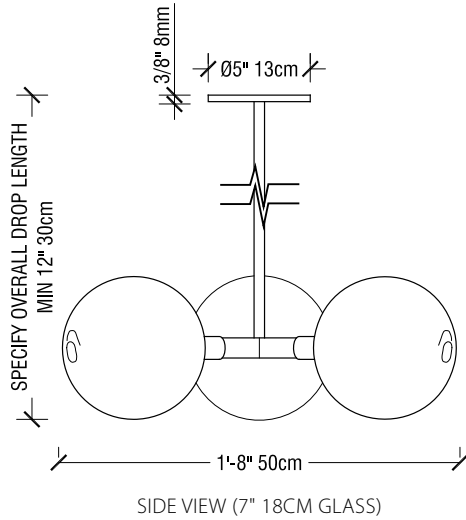

The stem 3x pendant is a minimal pendant consisting of three lit spheres of handblown Czech glass mounted on a three-arm horizontal armature and suspended on a rigid brass stem. The glass is available in two sizes – 4 1/2" (11cm) or 7" (18cm) in diameter – and five glass colors. The glass features the signature SkLO double-dipped, fire-polished mouths which show where the glass is broken from the blower's pipe, making each unique.

UL LISTED SUITABLE FOR DAMP LOCATIONS (US & CANADA)

Sockets: 120V E12 (candelabra) 7W Max (G9 socket available on request)

Canopy: Brass canopy with exposed fasteners. Recessed steel electrical box required for installation

Pendant suspended from canopy on rigid brass stem – not field adjustable

Specify overall drop length

Minimum overall drop length is 12" (30cm). Lengths over 53" (135cm) available at additional cost

Bulbs included

Standard metal finishes: dark oxidized / brushed brass (other finishes available on request)

Five glass colors available (including clear)

All glass dimensions are approximate – handblown glass dimensions vary by nature and intent

Handblown in the Czech Republic

transparent colors:



clear-CLR



olivin-OLV



smoke-SMK

opaque colors:



new blue-NBL



white-WHT

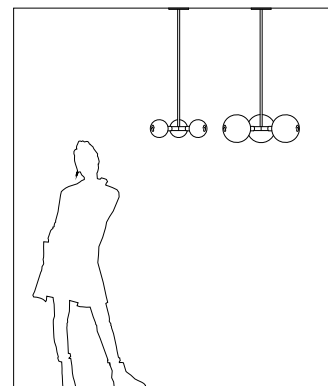

LT383 ---	stem pendant 3x	dark oxidized	4.5"Dia (11cm) glass
LT383 --- B	stem pendant 3x	brushed brass	4.5"Dia (11cm) glass
LT384 ---	stem pendant 3x	dark oxidized	7"Dia (18cm) glass
LT384 --- B	stem pendant 3x	brushed brass	7"Dia (18cm) glass

1'-2"Dia (36cm)
1'-2"Dia (36cm)
1'-8"Dia (50cm)
1'-8"Dia (50cm)



stem sconce / ceiling **1x**



stem 1x sconce shown with clear glass and brushed brass metal finish

stem sconce / ceiling 1x

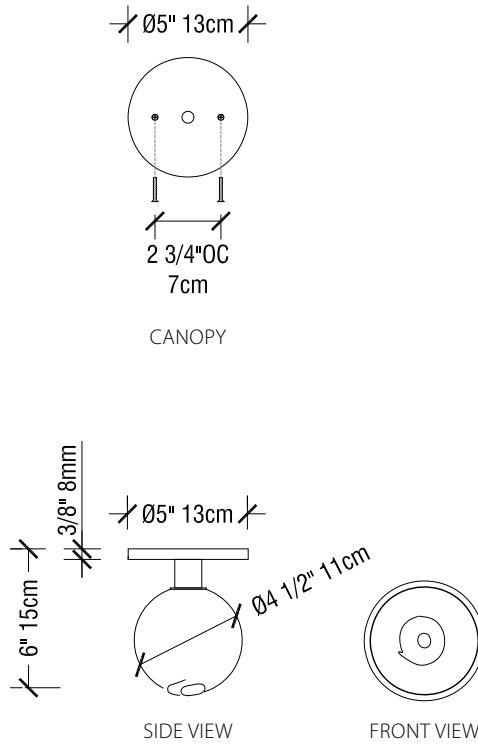

The *stem* 1x sconce/ceiling light is a minimal light suitable for use as a ceiling light or as a wall sconce. It consists of a single, 4 1/2" (11cm) diameter sphere of handblown Czech glass, featuring the signature SkLO double-dipped, fire-polished mouth which shows where the glass is broken from the blower's pipe, making each unique.

UL LISTED SUITABLE FOR DAMP LOCATIONS (US & CANADA)

Socket: 120V E12 (candelabra) 7W Max (G9 sockets available on request)

Canopy: Brass canopy with exposed fasteners. Recessed steel electrical box required for installation

Bulb included

Standard metal finishes: dark oxidized / brushed brass (other finishes available on request)

Five glass colors available (including clear)

All glass dimensions are approximate – handblown glass dimensions vary by nature and intent

Handblown in the Czech Republic

transparent colors:



clear-CLR



olivin-OLV



smoke-SMK

opaque colors:



new blue-NBL



white-WHT

LT271 --- stem sconce/ceiling 1x dark oxidized

LT271 --- B stem sconce/ceiling 1x brushed brass

6"H x 5"Dia (15x13cm)

6"H x 5"Dia (15x13cm)

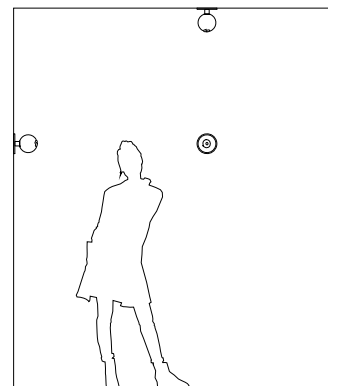

stem sconce / ceiling **2x**



stem 2x sconce shown with opaque white glass and dark oxidized metal finish

stem sconce / ceiling 2x

Ø5" 13cm

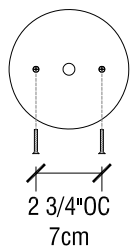

CANOPY

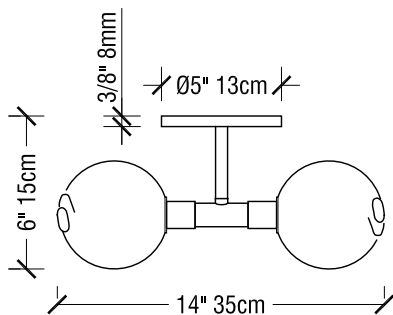

SIDE VIEW

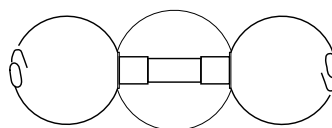

FRONT VIEW



The *stem 2x sconce/ceiling light* is a minimal light consisting of a pair of 4 1/2" (11cm) diameter lit spheres of handblown Czech glass on a simple brass armature. The light suitable for use as a ceiling light or as a wall sconce. The glass features the signature SkLO double-dipped, fire-polished mouths which show where the glass is broken from the blower's pipe, making each one unique.

UL LISTED SUITABLE FOR DAMP LOCATIONS (US & CANADA)

Sockets: 120V E12 (candelabra) 7W Max (G9 sockets available on request)

Canopy: Brass canopy with exposed fasteners. Recessed steel electrical box required for installation
Bulbs included

Standard metal finishes: dark oxidized / brushed brass (other finishes available on request)

Five glass colors available (including clear)

All glass dimensions are approximate – handblown glass dimensions vary by nature and intent

Handblown in the Czech Republic

transparent colors:



clear-CLR



olivin-OLV



smoke-SMK

opaque colors:



new blue-NBL



white-WHT

LT270 --- stem sconce/ceiling 2x dark oxidized
LT270 --- B stem sconce/ceiling 2x brushed brass

6"H x 14"W (15x35cm)
6"H x 14"W (15x35cm)

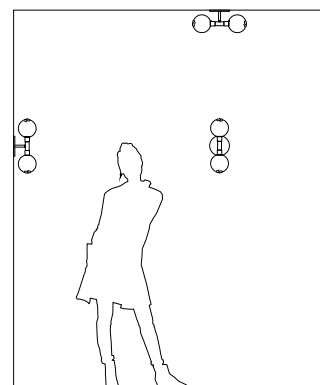

stem sconce / ceiling **3x**



*top: stem 3x shown on ceiling with 7" (18cm) opaque white glass and brushed brass metal finish
bottom: stem 3x shown on ceiling with 4 1/2" (11cm) opaque white glass and brushed brass metal finish*

stem sconce / ceiling 3x

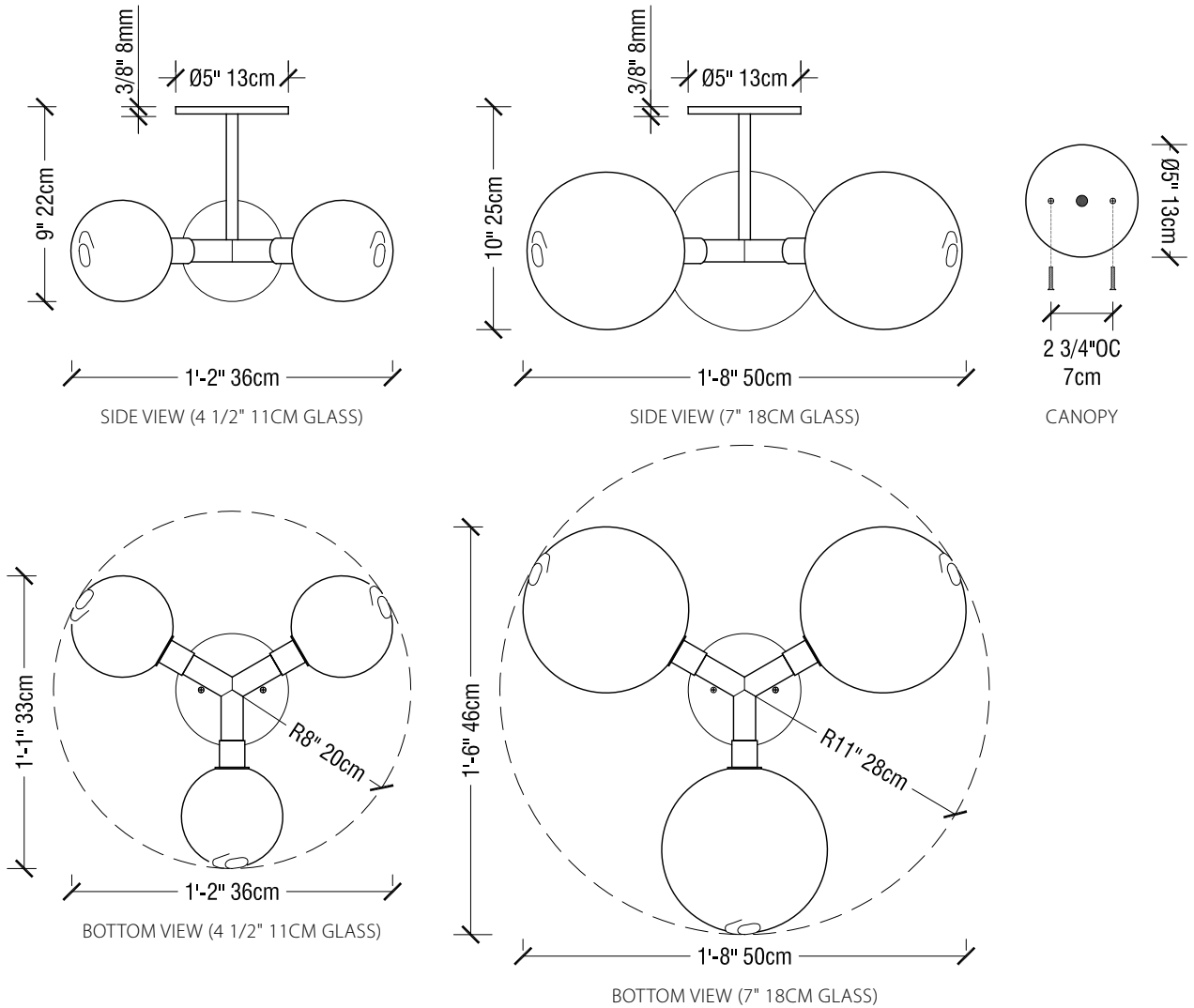

The stem 3x sconce/ceiling light is a minimal fixture consisting of three lit spheres of handblown Czech glass mounted on a three-arm horizontal armature. The light is suitable for use as a ceiling light or as a wall sconce. The glass is available in two sizes – 4 1/2" (11cm) or 7" (18cm) in diameter – and five glass colors.

UL LISTED SUITABLE FOR DAMP LOCATIONS (US & CANADA)

Socket(s): 120V E12 (candelabra) 7W Max (G9 sockets available on request)

Canopy: Brass canopy with exposed fasteners. Recessed steel electrical box required for installation

Bulbs included

Standard metal finishes: dark oxidized / brushed brass (other finishes available on request)

Five glass colors available (including clear)

All glass dimensions are approximate – handblown glass dimensions vary by nature and intent

Handblown in the Czech Republic

transparent colors:



clear-CLR



olivin-OLV



smoke-SMK

opaque colors:



new blue-NBL



white-WHT

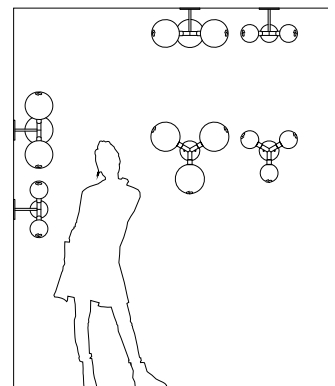

LT381 ---	stem sconce/ceiling 3x	dark oxidized	4.5"Dia (11cm) glass	1'-2"Dia (36cm)
LT381 --- B	stem sconce/ceiling 3x	brushed brass	4.5"Dia (11cm) glass	1'-2"Dia (36cm)
LT382 ---	stem sconce/ceiling 3x	dark oxidized	7"Dia (18cm) glass	1'-8"Dia (50cm)
LT382 --- B	stem sconce/ceiling 3x	brushed brass	7"Dia (18cm) glass	1'-8"Dia (50cm)

stem table 1x



stem 1x table shown with opaque white glass and brushed brass metal finish

stem table 1x

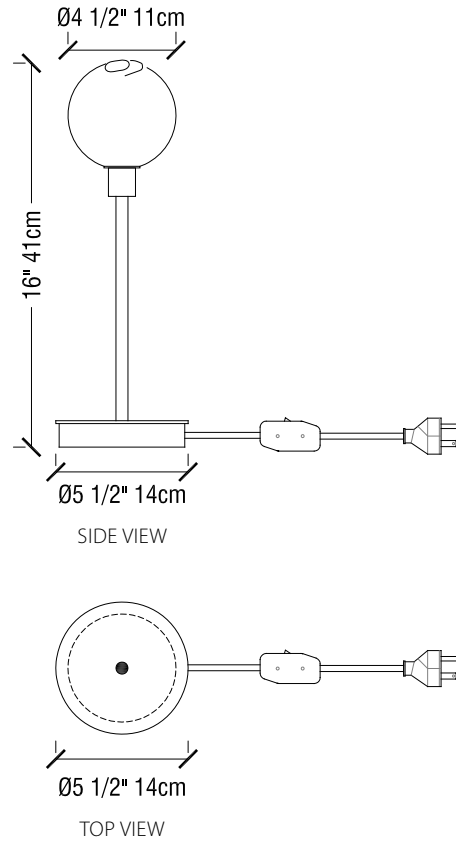

The *stem 1x* table light is a minimal design featuring a single, 4 1/2" (11 cm) handblown Czech glass sphere on a brass base. The glass features the signature SkLO double-dipped, fire-polished mouth which shows where the glass is broken from the blower's pipe, making each unique.

Socket: 120V E12 (candelabra) 7W Max (G9 sockets available on request)
 6 ft (180cm) black fabric-wrapped cord with in-line switch
 Bulb included

Standard metal finishes: dark oxidized / brushed brass (other finishes available on request)
 Five glass colors available (including clear)
 All glass dimensions are approximate – handblown glass dimensions vary by nature and intent
 Handblown in the Czech Republic

transparent colors:



clear-CLR



olivin-OLV



smoke-SMK

opaque colors:



new blue-NBL



white-WHT

LT272 --- **stem table 1x** dark oxidized
 LT272 --- B **stem table 1x** brushed brass

16"H x 5.5"Dia (41x14cm)
 16"H x 5.5"Dia (41x14cm)

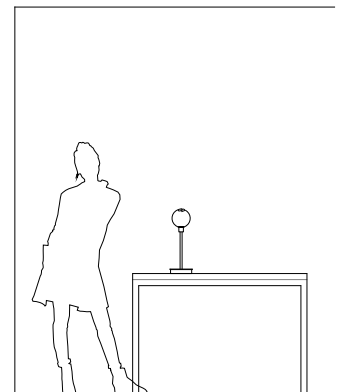

stem *table 2x*



stem 2x table shown with opaque white glass and brushed brass metal finish

stem table 2x

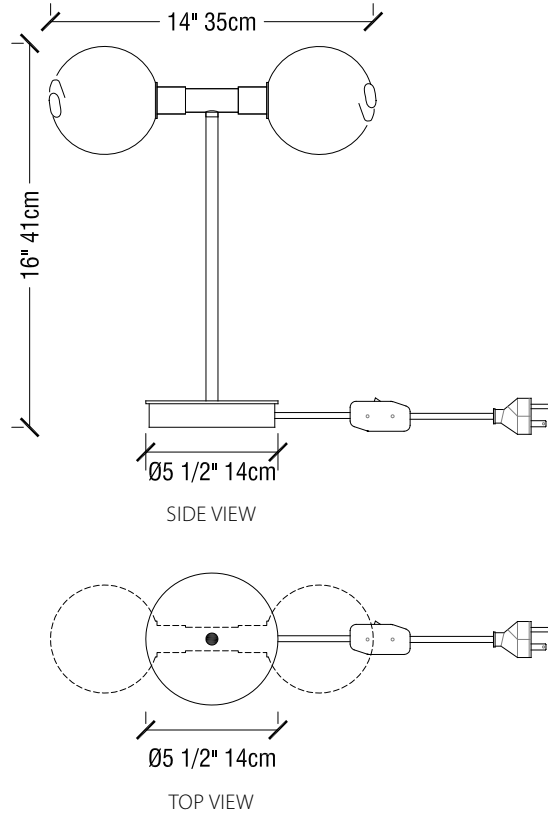

The *stem 2x* table light is a minimal fixture consisting of a pair of lit spheres of handblown Czech glass presented on a brass base. The spheres are 4 1/2" (11 cm) in diameter and feature the signature SkLO double-dipped, fire-polished mouths which show where the glass is broken from the blower's pipe, making each unique.

Sockets: 120V E12 (candelabra) 7W Max (G9 sockets available on request)
 6 ft (180cm) black fabric-wrapped cord with in-line switch
 Bulbs included

Standard metal finishes: dark oxidized / brushed brass (other finishes available on request)
 Five glass colors available (including clear)
 All glass dimensions are approximate – handblown glass dimensions vary by nature and intent
 Handblown in the Czech Republic

transparent colors:



clear-CLR



olivin-OLV



smoke-SMK

opaque colors:



new blue-NBL



white-WHT

LT273 --- **stem table 2x** dark oxidized
 LT273 --- B **stem table 2x** brushed brass

16"H x 14"W (41x35cm)
 16"H x 14"W (41x35cm)

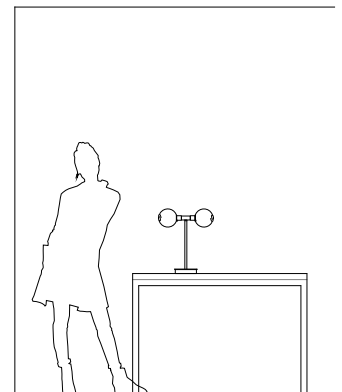

stem floor 1x



stem 1x floor shown with opaque white glass and brushed brass metal finish

stem floor 1x

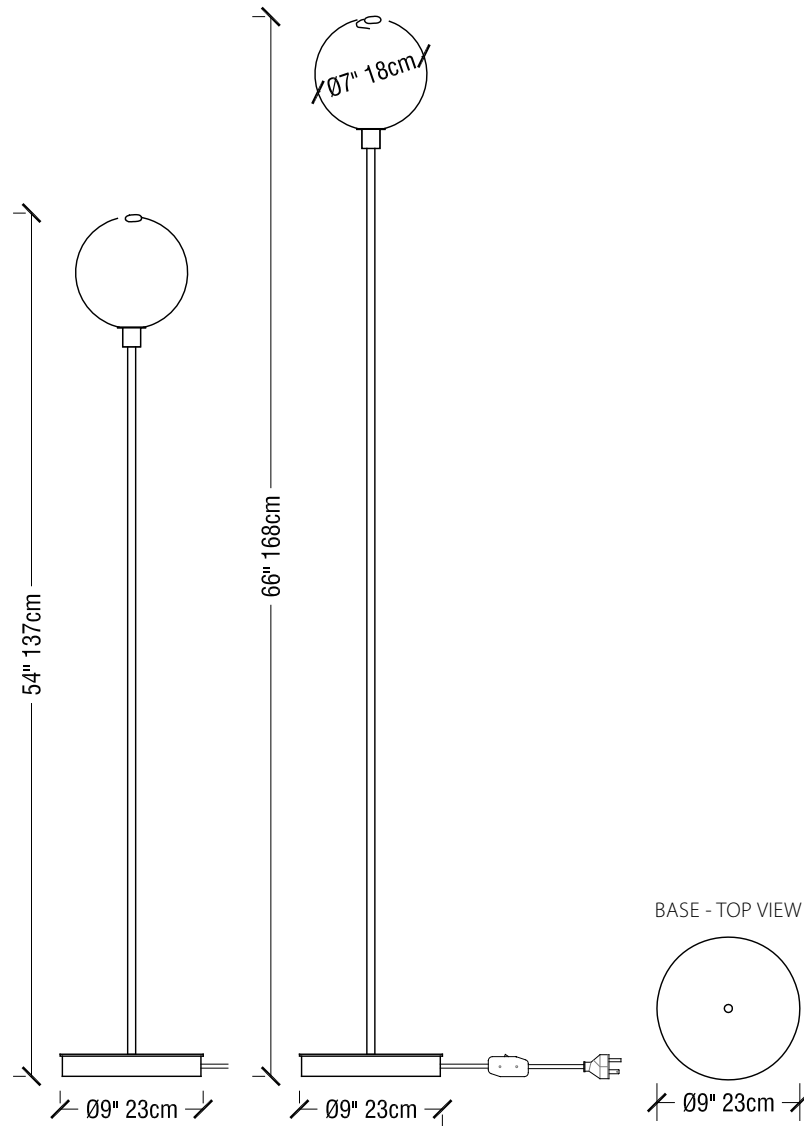

The *stem 1x* floor light is a minimal light consisting of a single, 7" (18cm) diameter sphere of handblown Czech glass on a brass base. The light is available in two different heights. The glass features the signature SkLO double-dipped, fire-polished mouth which shows where the glass is broken from the blower's pipe, making each unique.

Socket: 120V E12 (candelabra) 7W Max (G9 sockets available on request)

Two heights available

6 ft (180cm) black fabric-wrapped cord with in-line switch

Bulb included

Standard metal finishes: dark oxidized / brushed brass (other finishes available on request)

Five glass colors available (including clear)

All glass dimensions are approximate – handblown glass dimensions vary by nature and intent

Handblown in the Czech Republic

transparent colors:



clear-CLR



olivin-OLV



smoke-SMK

opaque colors:



new blue-NBL



white-WHT

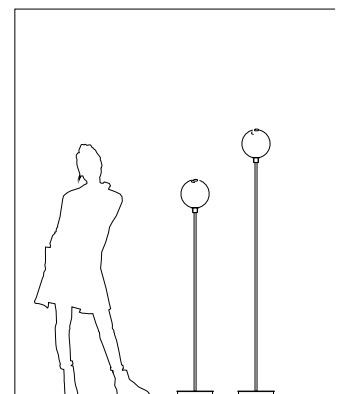

LT278 ---	stem floor 1x dark oxidized	7"Dia (18cm) glass	54"H (137cm)
LT278 --- B	stem floor 1x brushed brass	7"Dia (18cm) glass	54"H (137cm)
LT279 ---	stem floor 1x dark oxidized	7"Dia (18cm) glass	66"H (168cm)
LT279 --- B	stem floor 1x brushed brass	7"Dia (18cm) glass	66"H (168cm)



stem floor 2x



stem 2x floor shown with opaque white glass and brushed brass metal finish

stem floor 2x

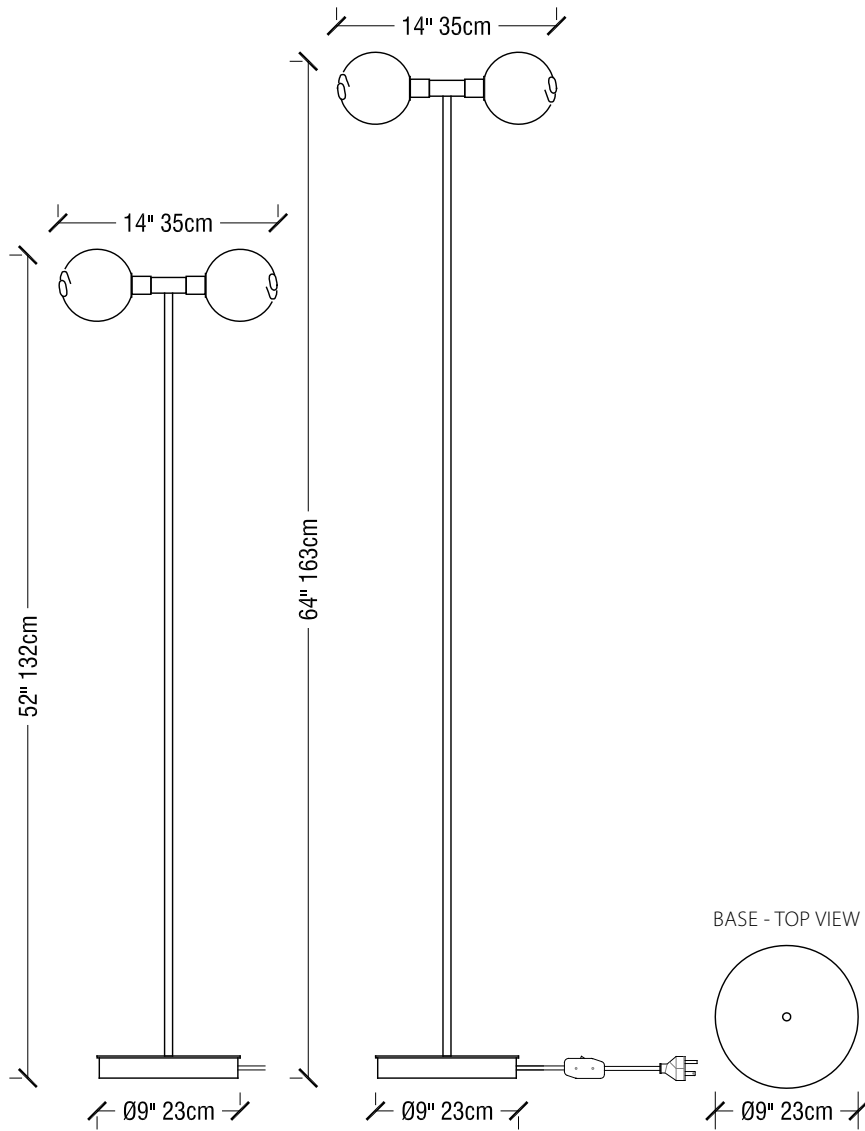

The *stem 2x* floor light is a minimal light consisting of a pair of lit spheres of handblown Czech glass presented on a brass base. The light is available in two different heights. The spheres are 4 1/2" (11 cm) in diameter and feature the signature SkLO double-dipped, fire-polished mouths which show where the glass is broken from the blower's pipe, making each unique.

Sockets: 120V E12 (candelabra) 7W Max (G9 sockets available on request)

Two heights available

6 ft (180cm) black fabric-wrapped cord with in-line switch

Bulbs included

Standard metal finishes: dark oxidized / brushed brass (other finishes available on request)

Five glass colors available (including clear)

All glass dimensions are approximate – handblown glass dimensions vary by nature and intent

Handblown in the Czech Republic

transparent colors:



clear-CLR



olivin-OLV



smoke-SMK

opaque colors:



new blue-NBL



white-WHT

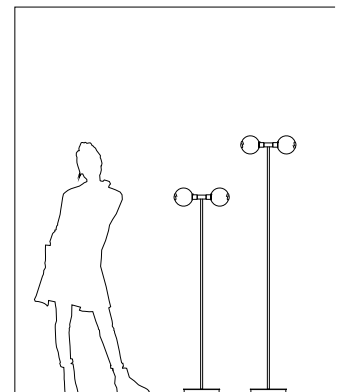

LT276 ---	stem floor 2x dark oxidized	4.5"Dia (11 cm) glass	52"H x 14"W (132x35cm)
LT276 --- B	stem floor 2x brushed brass	4.5"Dia (11 cm) glass	52"H x 14"W (132x35cm)
LT277 ---	stem floor 2x dark oxidized	4.5"Dia (11 cm) glass	64"H x 14"W (163x35cm)
LT277 --- B	stem floor 2x brushed brass	4.5"Dia (11 cm) glass	64"H x 14"W (163x35cm)



twice *light*



twice light shown with opaque white glass and brushed brass metal finish

twice light

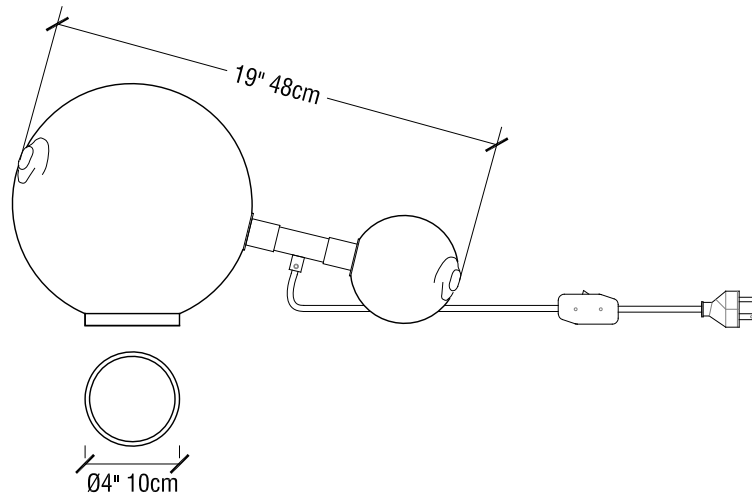

Twice consists of two lit spheres of handblown Czech glass connected by a cylindrical brass armature. Two different diameter spheres make for an asymmetrical light: one sphere is 4 1/2" (11 cm) diameter, the other is 10" (25 cm) diameter. A 4 1/2" (11 cm) diameter brass ring is included with the light and can be used under the larger sphere to stabilize the light – use of the ring is optional. The glass spheres each feature an off-center double-dipped fire-polished mouth where the piece is broken from the blower's pipe, making each unique. The central cylinder houses the sockets, with the bulbs accessible by unthreading the glass from the socket.

Sockets: 120V E12 (candelabra) 7W Max (G9 sockets available on request)
 6 ft (180cm) black fabric-wrapped cord with in-line switch
 Bulbs included

Standard metal finishes: dark oxidized / brushed brass (other finishes available on request)
 Available in two glass color combinations: all white / two color transparent smoke palette
 All glass dimensions are approximate – handblown glass dimensions vary by nature and intent
 Handblown in the Czech Republic

glass colors: *smoke palette-PSM white-WHT*

LT190 --- **twice light** dark oxidized
LT190 --- B **twice light** brushed brass

19"W (48cm)

19"W (48cm)

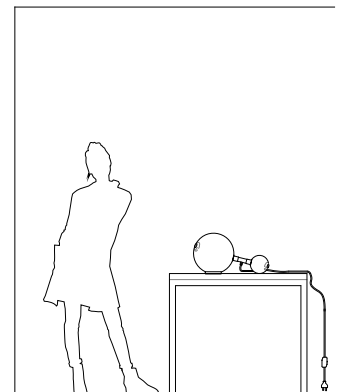

twin 1.0 *sconce*



twin 1.0 sconce shown with white palette glass and brushed brass metal finish

twin 1.0 *sconce*

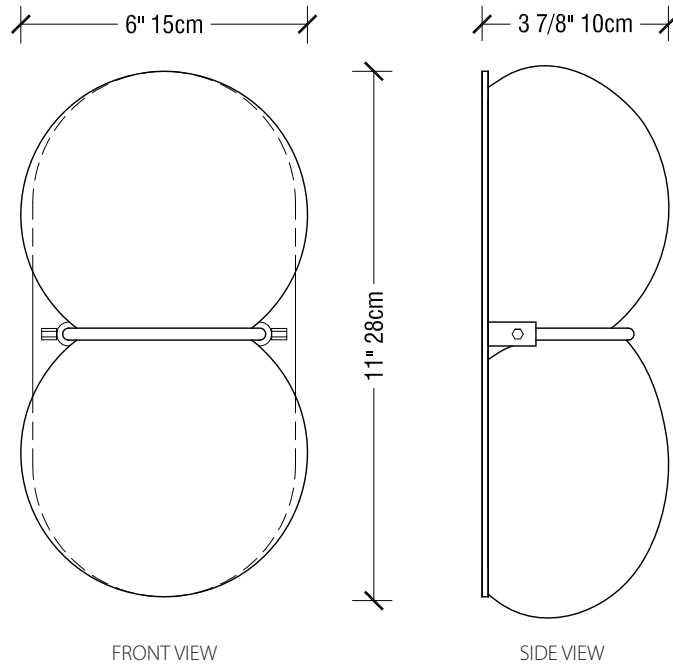

The *twin 1.0* sconce is a diffuser of handblown Czech glass made up of two flattened spherical shapes in two colors (one white, one off-white) which are melded together while hot on the glass blower's pipes. The glass is held to a solid brass plate canopy by a brass band which sits between the two spheres. Each sphere is lit from within by two light bulbs, one in each sphere. The *twin 1.0* sconce is designed to meet ADA requirements for commercial use in public spaces by always measuring less than 4" total depth from a wall surface.

UL LISTED SUITABLE FOR DAMP LOCATIONS (US & CANADA)
 Sockets: 120V E12 (candelabra) 7W Max
 Canopy: Brass canopy. Recessed electrical box required for installation
 Bulbs included

Standard metal finishes: dark oxidized / brushed brass (other finishes available on request)
 Two glass color palettes available
 All glass dimensions are approximate – handblown glass dimensions vary by nature and intent
 Handblown in the Czech Republic

glass colors: *blue palette-PBL* *white palette-WHT*

LTM06 --- twin 1.0 sconce dark oxidized
LTM06 --- B twin 1.0 sconce brushed brass

11"H x 6"W x 3 7/8"D (28x15x10cm)
 11"H x 6"W x 3 7/8"D (28x15x10cm)

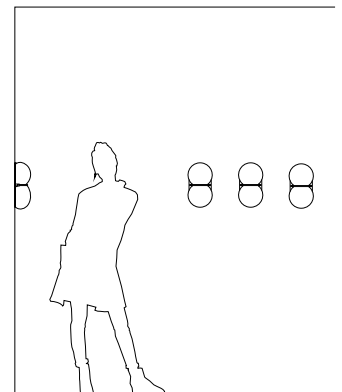

twin 2.0 *sconce / ceiling*



*top: twin 2.0 shown on ceiling with white palette glass and brushed brass metal finish
bottom: twin 2.0 shown on wall with blue palette glass and brushed brass metal finish*

twin 2.0 sconce / ceiling

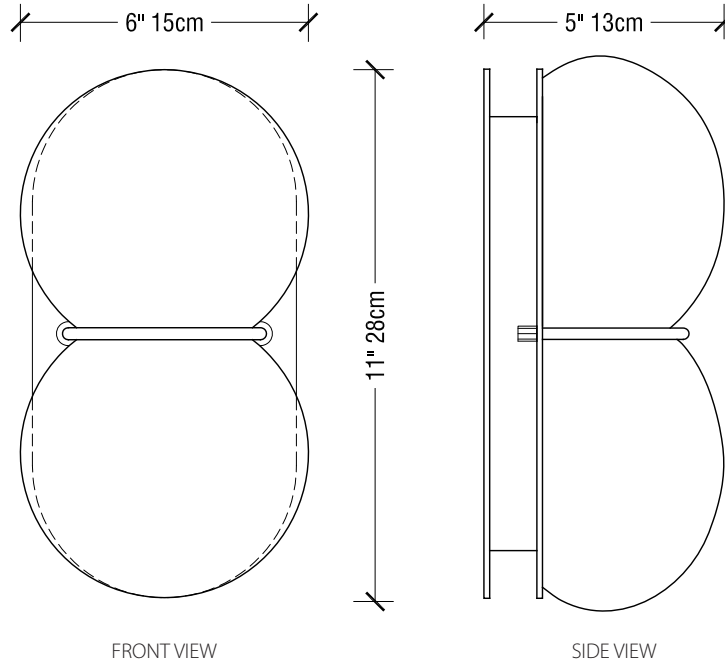

The *twin 2.0* sconce/ceiling is suitable for both wall and ceiling mounting. Featuring a diffuser of handblown Czech glass made up of two flattened spherical shapes, each in a slightly different color, which are melded together while still molten during the glass blowing process. The canopy consists of two rounded solid brass plates layered slightly apart for a dynamic look. The glass is held flush to the outer brass plate by a brass band that sits between the two spheres at the "waist" and fastens to the plate. Each sphere is lit from within by its own light source.

UL LISTED SUITABLE FOR DAMP LOCATIONS (US & CANADA)

Sockets: 120V E12 (candelabra) 7W Max

Canopy: Brass canopy. Recessed electrical box required for installation

Bulbs included

Standard metal finishes: dark oxidized / brushed brass (other finishes available on request)

Two glass color palettes available

All glass dimensions are approximate – handblown glass dimensions vary by nature and intent

Handblown in the Czech Republic

glass colors: *blue palette-PBL* *white palette-WHT*

LTM08 --- twin 2.0 sconce/ceiling dark oxidized

11"H x 6"W x 5"D (28x15x13cm)

LTM08 --- B twin 2.0 sconce/ceiling brushed brass

11"H x 6"W x 5"D (28x15x13cm)

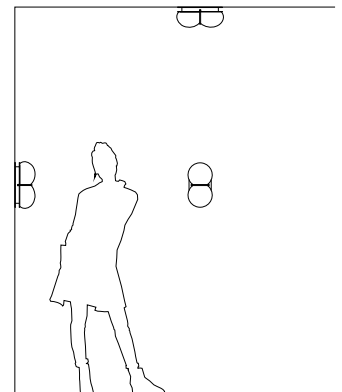

veer *light*



veer light shown with opaque white glass and brushed brass metal finish

veer light

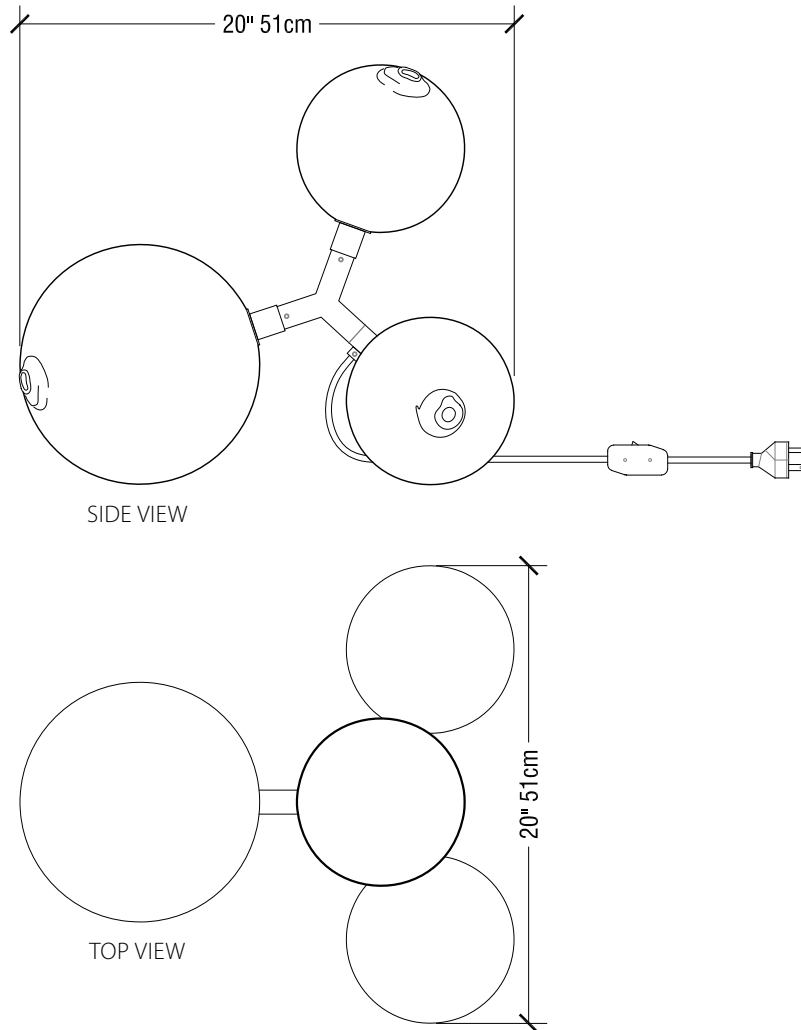

The SkLO *veer* light consists of four lit spheres of handblown Czech glass on a brass armature. Three of the spheres are 7" (18cm) in diameter, and the fourth is 10" (25cm) in diameter. The glass shapes feature double-dipped fire-polished mouths where the piece is broken from the blower's pipe, making each unique.

Sockets: 120V E12 (candelabra) 7W Max (G9 sockets available on request)
6 ft (180cm) black fabric-wrapped cord with in-line switch
Bulbs included

Standard metal finishes: dark oxidized / brushed brass (other finishes available on request)
Glass available in opaque white only
All glass dimensions are approximate – handblown glass dimensions vary by nature and intent
Handblown in the Czech Republic

LT380WHT *veer light* dark oxidized
LT380WHTB *veer light* brushed brass

20"W x 20"L (51x 51cm)
20"W x 20"L (51x 51cm)

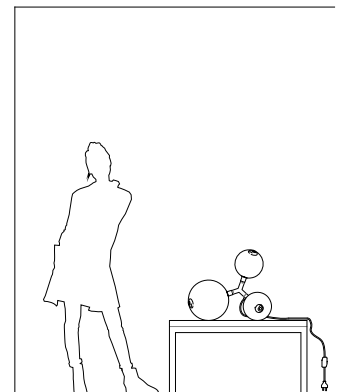

veer pendant



veer pendant shown with 4 1/2" (11cm) and 7" (18cm) opaque white glass and brushed brass metal finish

veer pendant

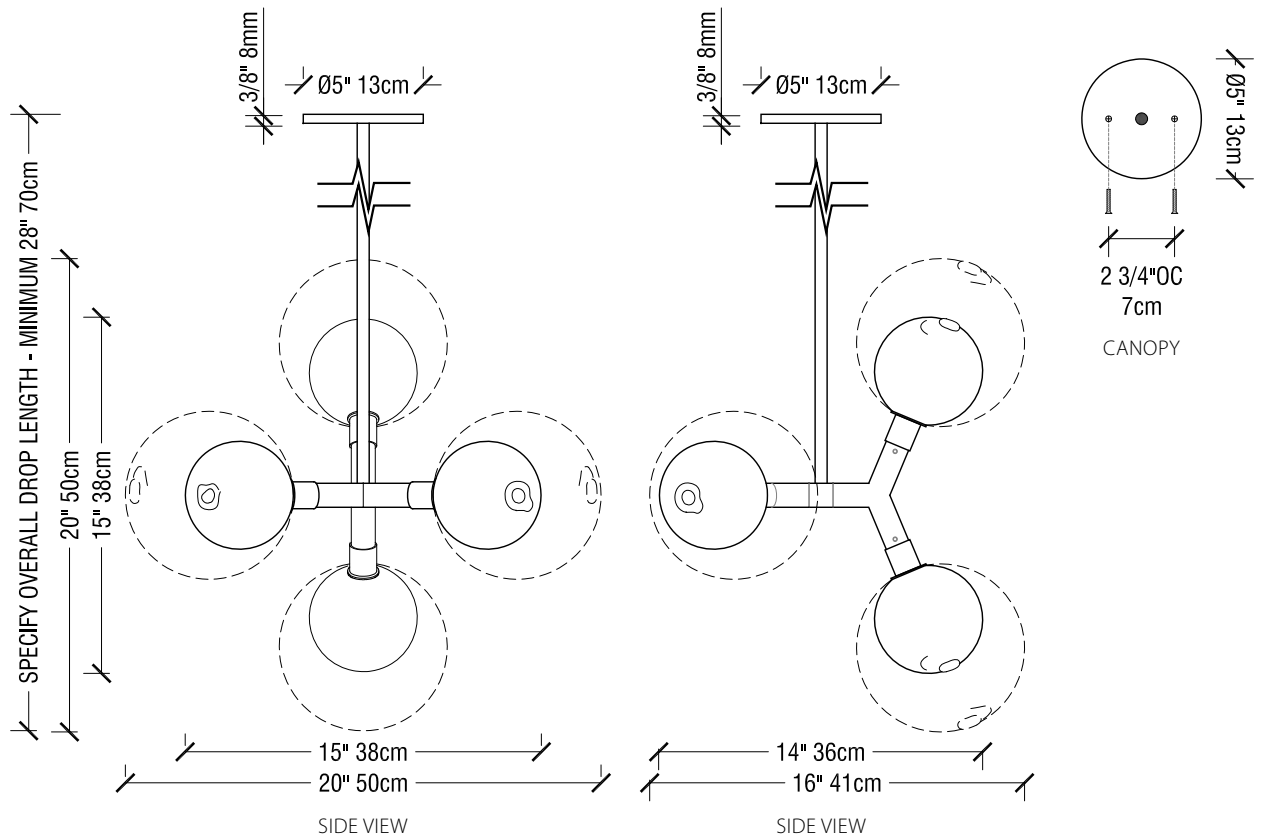

The *veer* pendant consists of four lit spheres of handblown Czech glass mounted on a four-arm brass structure and suspended on a rigid brass stem. The glass is available in two sizes – 4 1/2" (11cm) or 7" (18cm) in diameter – and five glass colors. The glass features the signature SkLO double-dipped, fire-polished mouths which show where the glass is broken from the blower's pipe, making each unique.

UL LISTED SUITABLE FOR DAMP LOCATIONS (US & CANADA)

Sockets: 120V E12 (candelabra) 7W Max (G9 socket available on request)

Canopy: Brass canopy with exposed fasteners. Recessed steel electrical box required for installation

Pendant suspended from canopy on rigid brass stem – not field adjustable

Specify overall drop length

Minimum overall drop length is 28" (70cm). Lengths over 60" (155cm) available at additional cost

Bulbs included

Standard metal finishes: dark oxidized / brushed brass (other finishes available on request)

Five glass colors available (including clear)

All glass dimensions are approximate – handblown glass dimensions vary by nature and intent

Handblown in the Czech Republic

transparent colors:



clear-CLR



olivin-OLV



smoke-SMK

opaque colors:



new blue-NBL



white-WHT

LT385 ---	veer pendant dark oxidized	4.5"Dia (11cm) glass	15"W (38cm)	14"D (36cm)
LT385 --- B	veer pendant brushed brass	4.5"Dia (11cm) glass	15"W (38cm)	14"D (36cm)
LT386 ---	veer pendant dark oxidized	7"Dia (18cm) glass	20"W (50cm)	16"D (41cm)
LT386 --- B	veer pendant brushed brass	7"Dia (18cm) glass	20"W (50cm)	16"D (41cm)

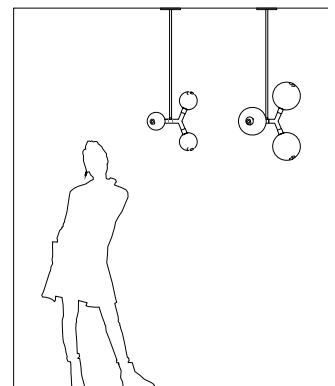

SkLO



wrap *light*



wrap light shown with opaque white glass and brushed brass metal finish

wrap light

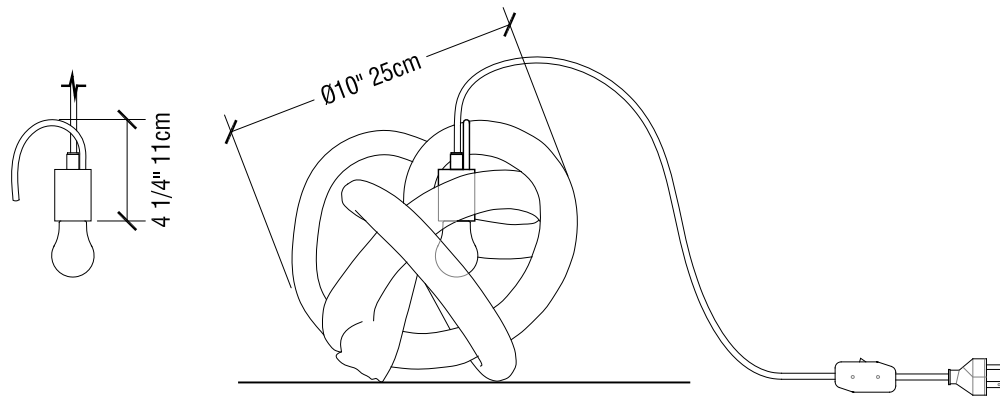

Our signature SkLO *large wrap* object, a continuous wound length of handblown Czech glass tube, is transformed here into a dynamic table light. The brass light socket has an integral handmade brass hook that allows it to attach to the glass *wrap*, suspending the bulb within. Each *wrap* is unique, no two exactly alike.

Socket: 120V E26 60W Max
 6 ft (180cm) black fabric-wrapped cord with in-line switch
 Bulb included

Two metal finishes available: dark oxidized / brushed brass (other finishes available on request)
 Glass available in seven colors (including clear) and one mirrored finish
 All glass dimensions are approximate – handblown glass dimensions vary by nature and intent
 Handblown in the Czech Republic

transparent colors:



clear-CLR



amber-AMB



smoke-SMK



steel blue-SBL



gray-GRY



new blue-NBL



white-WHT

mirrored:



silver-SLV

LT125 ---
 LT125 --- B

wrap light dark oxidized
wrap light brushed brass

10" Dia (25cm)
 10" Dia (25cm)

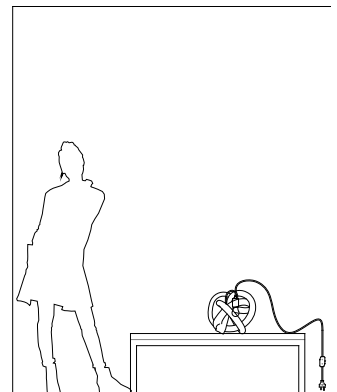

wrap pendant



wrap pendant shown with transparent steel blue glass and black fabric-wrapped cord

wrap pendant

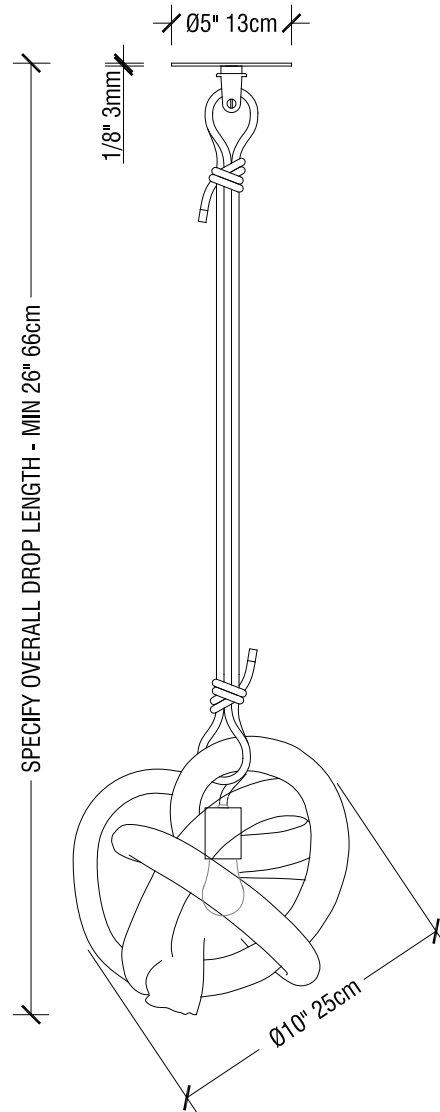

The SkLO *wrap* pendant light uses our signature SkLO *large wrap* object, a continuous wound length of handblown Czech glass tube, as a dynamic shade for a single bulb. Suspended on a hand-tied length of fabric-wrapped electrical cord – please specify length when ordering. Each *wrap* is unique, no two exactly alike.

UL LISTED SUITABLE FOR DAMP LOCATIONS (US & CANADA)

Socket: 120V E26 60W Max

Canopy: Brass canopy with exposed fasteners. Recessed steel electrical box required for installation

Pendant suspended from canopy on fabric-wrapped electrical cord

Specify overall drop length

Minimum overall drop length is 26" (66cm). Lengths over 48" (122cm) available at additional cost

Specify fabric-wrapped electrical cord color: black, blue, gold, or gray

Bulb included

Two metal finishes available: dark oxidized / brushed brass (other finishes available on request)

Glass available in seven colors (including clear) and one mirrored finish

Four fabric-wrapped electrical cord colors available

All glass dimensions are approximate – handblown glass dimensions vary by nature and intent

Handblown in the Czech Republic

transparent colors:



clear-CLR



amber-AMB



smoke-SMK



steel blue-SBL



gray-GRY



new blue-NBL



white-WHT

opaque colors:

mirrored:



silver-SLV

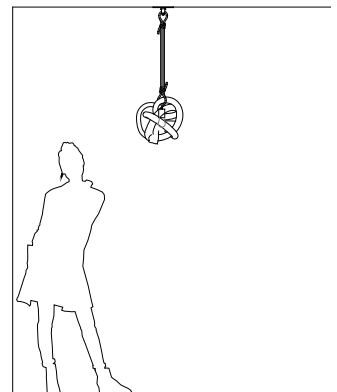

LT120 --- **wrap pendant** dark oxidized
 LT120 --- B **wrap pendant** brushed brass

10" Dia (25cm) glass

10" Dia (25cm) glass

cord colors available



black blue gold gray



wrap pin *pendant*



wrap pin pendant shown without stem extension, with clear glass, brushed brass metal finish and gold fabric-wrapped cord

wrap pin pendant

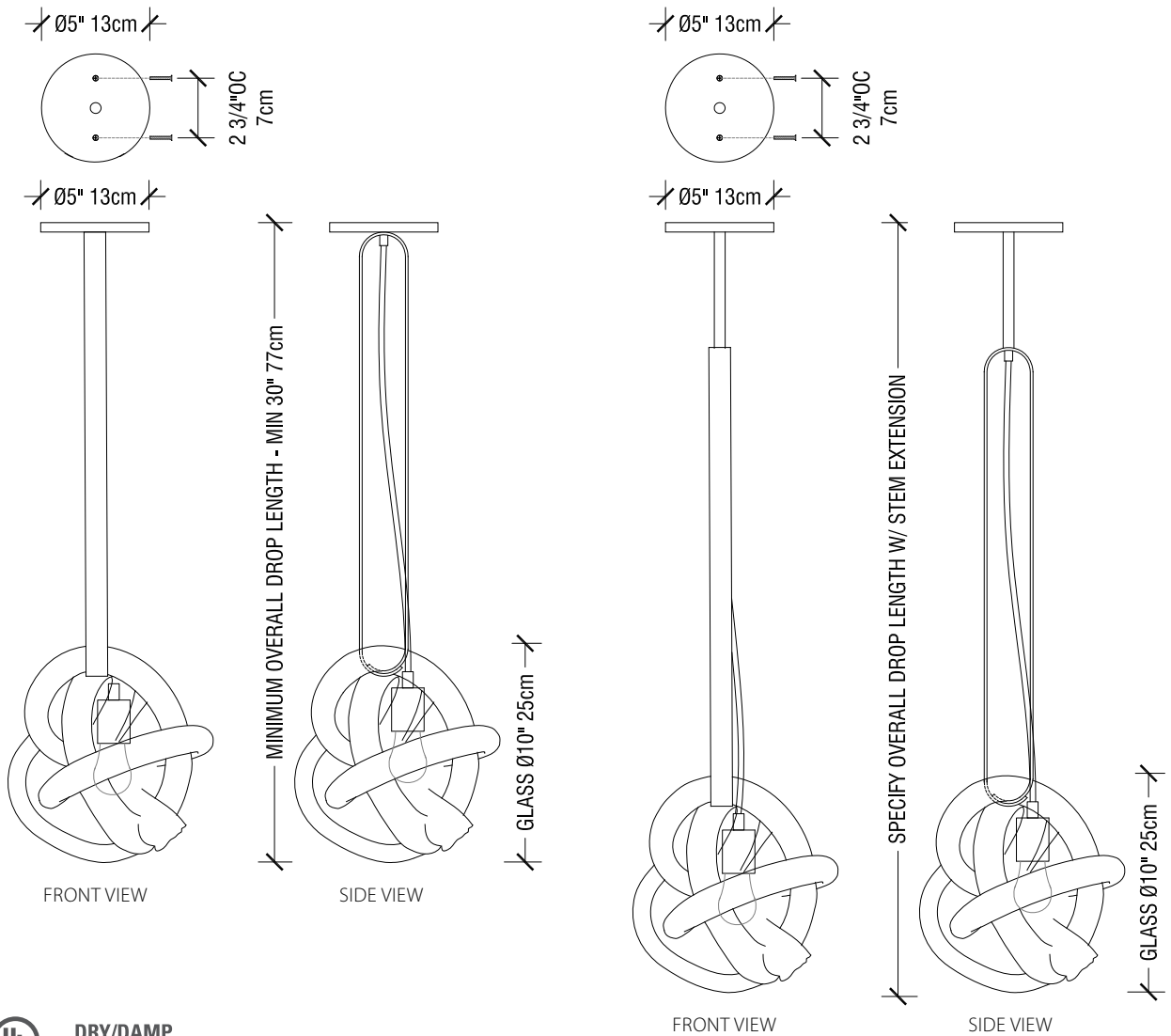

A SkLO *large wrap* is suspended from a brass "pin", made of a continuously curved brass bar. The "pin" overlaps at the bottom, allowing for removal of the glass element. The socket is housed in a brass cup, hung independently on its own exposed fabric-wrapped electrical cord, suspending the bulb within the *large wrap* glass element. Handblown glass, no two exactly alike.

UL LISTED SUITABLE FOR DAMP LOCATIONS (US & CANADA)

Socket: 120V E26 60W Max

Canopy: Brass canopy with exposed fasteners. Recessed steel electrical box required for installation

Specify overall drop length

Minimum overall drop length is 30"/77cm (no stem extension). Lengths over 68"/173cm available at additional cost

Specify fabric-wrapped electrical cord color: black, blue, gold, or gray

Bulb included

Two metal finishes available: dark oxidized / brushed brass (other finishes available on request)

Glass available in seven colors (including clear) and one mirrored finish

Four fabric-wrapped electrical cord colors available

All glass dimensions are approximate – handblown glass dimensions vary by nature and intent

Handblown in the Czech Republic

transparent colors:



clear-CLR



amber-AMB



smoke-SMK



steel blue-SBL



gray-GRY



new blue-NBL



white-WHT

mirrored:



silver-SLV

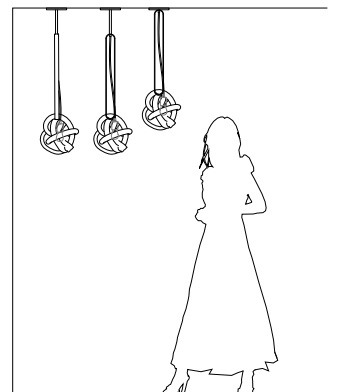

LT126 --- wrap pin pendant dark oxidized
LT126 --- B wrap pin pendant brushed brass

10"Dia (25cm) glass
10"Dia (25cm) glass

cord colors available



black blue gold gray



Apr 2020



SKLO : OBJECT



from left: small pink palette, large blue palette, medium olive palette

bloom object

SkLO *bloom* objects are organic sculptural compositions of multiple smaller pod-shapes fused together while hot to form large pieces. Bottoms are cut and polished. No two exactly alike.

Three sizes, each size available in one color as shown

All glass dimensions are approximate – handblown glass dimensions vary by nature and intent
Handblown in the Czech Republic

SC380PNK	bloom object small <i>pink palette</i>	9"H (23cm)
SC381OLP	bloom object medium <i>olive palette</i>	14"H (36cm)
SC382BLU	bloom object large <i>blue palette</i>	16"H (40cm)

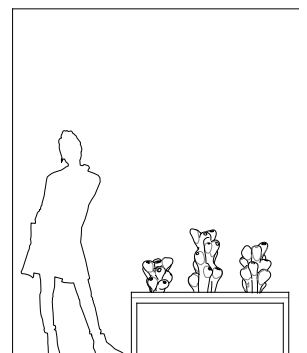



bloom *wallpiece*

A version of the SkLO *bloom* object meant for display on the wall, the *bloom* wallpiece is produced in a similar process, organically building sculptural compositions by layering together smaller individually blown pod-shapes while hot. The backs are cut and polished. Simple hardware for mounting on the wall is included and suitable for most wall materials.

Available in blue palette glass only

All glass dimensions are approximate – handblown glass dimensions vary by nature and intent
Handblown in the Czech Republic

SC485BLU	bloom <i>wallpiece</i> small	9"L x 6"W x 2.5"H (23x15x6.5cm)
SC486BLU	bloom <i>wallpiece</i> medium	10.5"L x 8"W x 2.5"H (27x20x6.5cm)
SC487BLU	bloom <i>wallpiece</i> large	13"L x 9"W x 2.5"H (33x23x6.5cm)

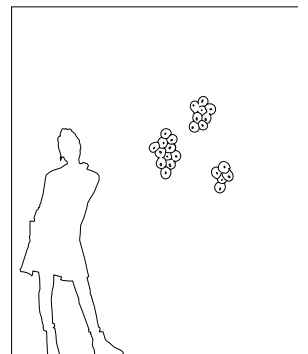



clockwise from left: olivin/14"H, amber/ 22"H, lagoon/18"H, steel blue/10"H, heliotrope/8"H

bottle vessel

SkLO bottles are expressive vertically proportioned vessels. The necks are double-dipped, and the mouths broken hot from the glass blower's pipe and fire polished. The bottoms have a slight indent detail, a reference to classic glass bottle design. Handblown, no two exactly alike.

Available in five unique sizes, colors available only as shown

All glass dimensions are approximate – handblown glass dimensions vary by nature and intent
Handblown in the Czech Republic

SC370HEL	bottle vessel heliotrope	8"H x 4"Dia (20x10cm)
SC371SBL	bottle vessel steel blue	10"H x 4.5"Dia (25x12cm)
SC372OLV	bottle vessel olivin	14"H x 5"Dia (35x13cm)
SC373LAG	bottle vessel lagoon	18"H x 5.5"Dia (45x14cm)
SC374AMB	bottle vessel amber	22"H x 7.5"Dia (55x19cm)

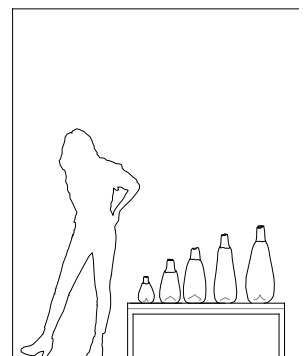

SkLO





coil 48 *object*

Twisting tubes of handblown glass with cut and polished ends, the SkLO *coil 48* object showcases the inimitable clarity and thickness of Czech glass, embodying the ability of glassblowing to capture the kinetic moment in time. Handblown, no two individual SkLO *coil 48* objects are alike. *Coil 48* is sold individually, in intertwine-able groups of three, or in intertwine-able groups of three with a handmade steel table stand.

Glass available in three colors (including clear)

All glass dimensions are approximate – handblown glass dimensions vary by nature and intent
Handblown in the Czech Republic

transparent colors:



clear-CLR



amber-AMB

opaque colors:



white-WHT

SC121 ---	coil 48 <i>object</i> single	48"L x 12"H (122x30cm)
SC125 ---	coil 48 <i>object</i> set of 3	52"L x 12"H (132x30cm)
SC127 ---	coil 48 <i>object</i> set of 3 w/ stand <i>dark oxidized</i>	58"L x 16"H x 14"D (147x41x36cm)
SC127 --- N	coil 48 <i>object</i> set of 3 w/ stand <i>polished nickel</i>	58"L x 16"H x 14"D (147x41x36cm)

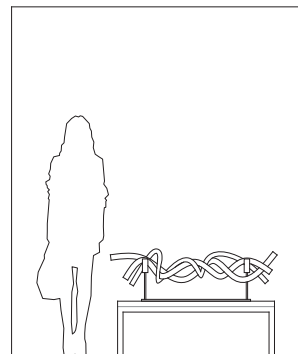

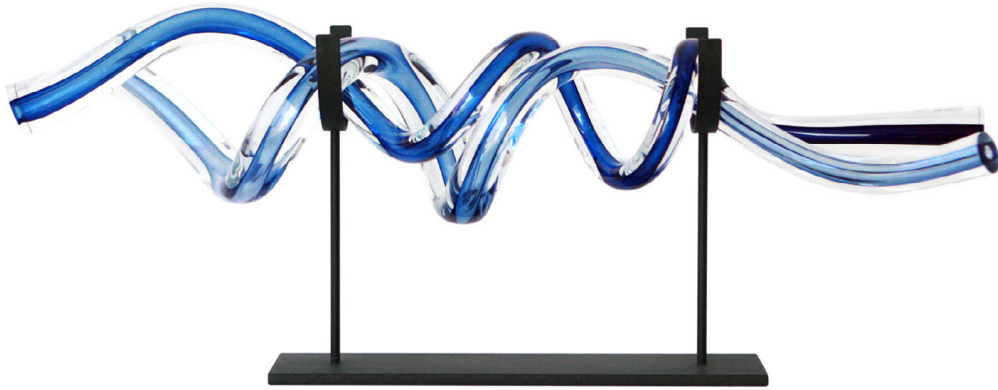

coil 32 *object*

The SkLO *coil 32* object is a slightly smaller version of the *coil 48*. Twisting tubes of handblown glass with cut and polished ends, the SkLO *coil 32* object showcases the inimitable clarity and thickness of Czech glass, embodying the ability of glassblowing to capture the kinetic moment in time. Coil 32 is sold in intertwine-able sets of three, or intertwine-able pairs on a steel table stand.

Glass available in two colors (including clear)

Stand available in dark oxidized finish only

All glass dimensions are approximate – hand blowing glass dimensions vary by nature and intent
Handblown in the Czech Republic

available in transparent colors:



clear-CLR



steel blue-SBL

SC135 ---

coil 32 *object* set of 3

33"L x 6.5" H x 7"D (84x17x18cm)

SC136 ---

coil 32 *object* set of 2 w/ stand

36"W x 14"H x 9"D (91x36x23cm)

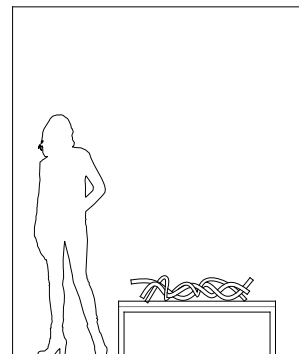



from left: shape 1, shape 5, shape 2, shape 4, shape 3 and shape 6

crescent vessel

Minimal double-sided vessels composed of two different shapes in different transparent colors. Each half of each shape is a different diameter and proportion, with hemispherical ends joined dynamically together just where the two curves meet. The open ends are cut and polished so that the vessels can be oriented with either end up. Six unique shapes, in a bright palette of carefully combined colors. Handblown in the Czech Republic.

Six unique shapes, colors available only as shown

All glass dimensions are approximate – handblown glass dimensions vary by nature and intent
Handblown in the Czech Republic

VA741PLC	crescent vessel shape 1 plum/copper ruby	11"H x 6"Dia (29x15cm)
VA742TBL	crescent vessel shape 2 tourmaline/steel blue	24"H x 6"Dia (61x15cm)
VA743COV	crescent vessel shape 3 copper ruby/violet	30"H x 9"Dia (76x23cm)
VA744TRP	crescent vessel shape 4 pine tree green/plum	18"H x 5"Dia (46x12cm)
VA745STR	crescent vessel shape 5 steel blue/pine tree green	12"H x 5"Dia (31x12cm)
VA746TVI	crescent vessel shape 6 tourmaline/violet	10"H x 9"Dia (25x23cm)
VA747MIX	crescent vessel set of 6	



SkLO





from left: small round, round, and tall

dew vessel

SkLO *dew* vessels are substantial, visually complex pieces that evoke the molten nature of handblown glass. They start as simply shaped vessels of opaque colored glass which are then layered with dripping pieces of molten clear glass. The outside is then given a sandblasted finish. The tops are then cut and polished to reveal the unique details of the layers. Bottoms are cut and polished. No two exactly alike.

Three shapes

Available in lavender glass only

All glass dimensions are approximate – handblown glass dimensions vary by nature and intent

Handblown in the Czech Republic

VA315LAV	dew vessel small round lavender	3.5"H x 6.5"Dia (9x17cm)
VA316LAV	dew vessel round lavender	8"H x 10"Dia (20x26cm)
VA317LAV	dew vessel tall lavender	13"H x 9.5"Dia (34x24cm)

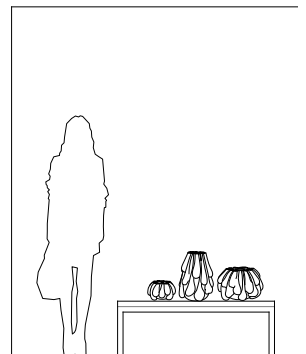

SkLO





from left: opaque blue palette, transparent blue palette



from left: opaque red palette, transparent red palette

drink cup

Drink is a collection of minimal glassware with a focus on color. Available in sets of four, in four palettes of either opaque or transparent glass colors. *Drink* are intentionally irregular, with a distinct off-center attitude that identifies them as skillfully handmade. Each is individually handblown, no two are exactly alike.

Available in four color palettes

All glass dimensions are approximate – handblown glass dimensions vary by nature and intent
Handblown in the Czech Republic

available in: *opaque blue-POB* *transparent blue-PTB* *opaque red-POR* *transparent red-PTR*

CU101 ---

drink cup set of 4

4"H x 3.5"Dia (10x9cm)

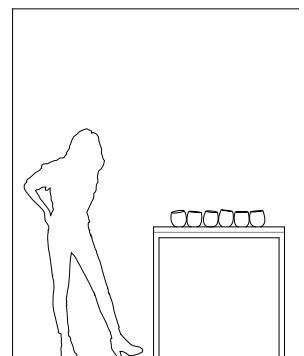



from left: amber, lagoon, olivin

droplet vessel

The SkLO *droplet* vessels are a collection of three small- to medium-sized vessels, each unique in shape and color. The vessels are asymmetrical, each a mass of solid Czech glass around a complementary shaped void of transparent color. Three vessels in three colors, only as shown. Meant to be displayed as a group, they are available as a set of all 3.

Three vessels in three colors, only as shown
 All glass dimensions are approximate – handblown glass dimensions vary by nature and intent
 Handblown in the Czech Republic

- | | | |
|-----------------|---|-------------------------------|
| VA724OLV | droplet vessel shape 4 <i>olivin</i> | 11"H x 5"W x 5"D (27x13x13cm) |
| VA725LAG | droplet vessel shape 5 <i>lagoon</i> | 6"H x 6"W x 4"D (15x15x10cm) |
| VA727AMB | droplet vessel shape 7 <i>amber</i> | 10"H x 5"W x 4"D (25x12x10cm) |

VA728MIX **droplet vessel** collection 2 *set of 3*

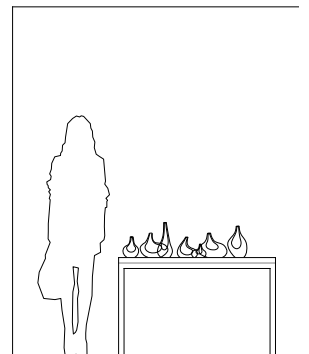



clockwise from left: olivin, fuchsia, smoke, heliotrope, lemon green, lagoon, tangerine

droplet vessel

The SkLO *droplet* vessels are a collection of seven small- to medium-sized vessels, each unique in shape and color. The vessels are asymmetrical, each a mass of solid Czech glass around a complementary shaped void of transparent color. Seven vessels in seven colors, only as shown. While the *droplet* vessels work individually, they are meant to be displayed in groups, and they are available as a set of all 7.

Seven vessels in seven colors, only as shown

All glass dimensions are approximate – hand blown glass dimensions vary by nature and intent
Handblown in the Czech Republic

VA721TNG	droplet vessel shape 1 <i>tangerine</i>	5"H x 5"W x 3"D (12x12x8cm)
VA722LAG	droplet vessel shape 2 <i>lagoon</i>	6"H x 4"W x 3"D (15x10x8cm)
VA723OLV	droplet vessel shape 3 <i>olivin</i>	6"H x 7"W x 5"D (16x18x12cm)
VA724FUS	droplet vessel shape 4 <i>fuchsia</i>	11"H x 5"W x 5"D (27x13x13cm)
VA725LMG	droplet vessel shape 5 <i>lemon green</i>	6"H x 6"W x 4"D (15x15x10cm)
VA726SMK	droplet vessel shape 6 <i>smoke</i>	7"H x 8"W x 8"D (18x20x20cm)
VA727HEL	droplet vessel shape 7 <i>heliotrope</i>	10"H x 5"W x 4"D (25x12x10cm)

VA720MIX **droplet vessel** collection 1 *set of 7*

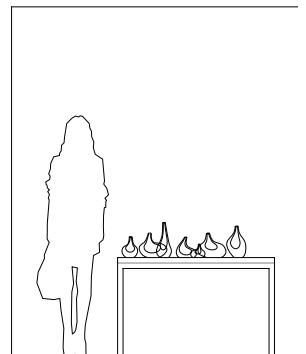



from left: small pewter, medium gold, medium silver and large blue

echo vessel

The SkLO *echo* vessels are rounded asymmetrical shapes of handblown Czech glass in transparent colors with dimpled voids at their tops. The vessels are mirror-finished from the inside, giving them their distinct metallic reflective surface. Intentionally off-center, each *echo* evokes its handblown origins.

Three sizes, four colors

All glass dimensions are approximate – handblown glass dimensions vary by nature and intent
Handblown in the Czech Republic

available in mirrored: blue-BLU gold-GLD pewter-PEW silver-SLV

BL720 ---	echo vessel small	6"H x 8"Dia (15x20cm)
BL721 ---	echo vessel medium	7"H x 12"Dia (18x30cm)
BL722 ---	echo vessel large	12"H x 17"Dia (30x43cm)

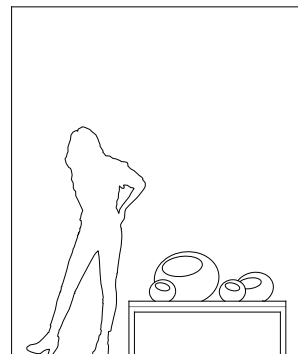



large in olivin



from left: small in sargasso, smoke, and plum

expand bowl

Made entirely without the use of moulds, *expand* bowls are intentionally irregular and highly organic, to showcase both the skill it takes to produce them, yet tell a story about their handmade origins.

Two sizes

Small available in three colors

Large available in one color

All glass dimensions are approximate – handblown glass dimensions vary by nature and intent

Handblown in the Czech Republic

small available in:



plum-PLM



sargasso-SGR



smoke-SMK

large available in:



olivin-OLV

CH176 ---

expand bowl small

16" Dia x 4"H (40x10cm)

CH177 ---

expand bowl large

22" Dia x 5"H (56x13cm)

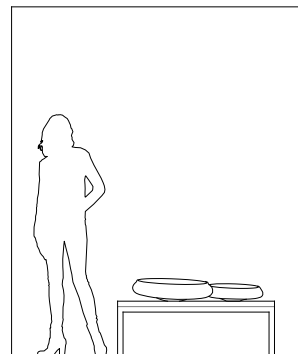

SkLO





from left: 6" whiskey, 8" fuchsia, 12" strawberry, 16" sargasso, 20" plum



from left: 6" light green, 8" smoke, 12" lime, 16" pine tree green, 20" steel blue

float vessel

The SkLO *float* vessels are organic spheres of Czech glass with broken flame polished mouths. They are entirely free-blown, produced without the use of moulds to shape them. The tops are given a slight ripple where they are dipped twice into the molten glass, and the mouths broken from the blowpipe and fire polished while hot.

These subtle details elevate the simple sphere to a unique thing of beauty that speaks entirely of the craft of glass blowing. The *float* vessels come in 5 sizes, and each size is available in two different colors, making up two different color palettes. The color palettes reflect the idea that floats work best in groups, with the color palettes carefully curated to allow for many possibilities.

All glass dimensions are approximate – handblown glass dimensions vary by nature and intent
Handblown in the Czech Republic

VA251LGR	float vessel light green	6"Dia (15cm)
VA251WHS	float vessel whiskey	6"Dia (15cm)
VA252FUS	float vessel fuchsia	8"Dia (20cm)
VA252SMK	float vessel smoke	8"Dia (20cm)
VA253LIM	float vessel lime	12"Dia (30cm)
VA253STB	float vessel strawberry	12"Dia (30cm)
VA254PTG	float vessel pine tree green	16"Dia (41cm)
VA254SGR	float vessel sargasso	16"Dia (41cm)
VA255PLM	float vessel plum	20"Dia (51cm)
VA255SBL	float vessel steel blue	20"Dia (51cm)

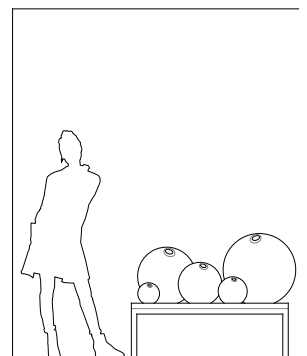

SkLO





clear



olivin



smoke

transparent colors



gray



new blue
opaque colors



white

hold vessel

The SkLO *hold* vessel is a glass wall vase that appears to stretch from the hook on which it hangs. Executed in handblown glass and hung from a hand made hook, SkLO *hold* vessels can be functional vases, or sculptural objects, and benefit from being shown in multiple. Handblown, no two *hold* vessels are exactly alike.

Available in six glass colors

Hooks available in three metal finishes: dark oxidized / brushed brass / polished nickel

All glass dimensions are approximate – handblown glass dimensions vary by nature and intent
Handblown in the Czech Republic

available in: clear-CLR olivin-OLV smoke-SMK gray-GRY new blue-NBL white-WHT

VA261 ---	hold vessel w/ hook dark oxidized	17"H x 8"W x 4"D (43x20x10cm)
VA261 --- B	hold vessel w/ hook brushed brass	17"H x 8"W x 4"D (43x20x10cm)
VA261 --- N	hold vessel w/ hook polished nickel	17"H x 8"W x 4"D (43x20x10cm)

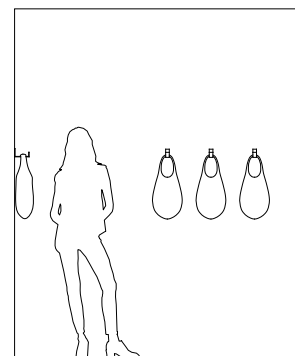



lasso *object/wallpiece*

Solid loops of handblown Czech glass, each *lasso* piece consists of a group of five loops of varying sizes so each piece is a composition unto itself, showcasing the amazing depth and clarity of Czech glass. Every loop is unique, an expression of the hand of the glassmaster – no two exactly alike. As either a tabletop object or wallpiece, *lasso* works as an individual object, or in multiples.

Glass available in two colors (including clear)

Wall hooks available in three metal finishes: dark oxidized / brushed brass / polished nickel

Table stands available in two metal finishes: dark oxidized / polished nickel

All glass dimensions are approximate – handblown glass dimensions vary by nature and intent
Handblown in the Czech Republic

available in: clear-CLR white-WHT

SC101 --- **lasso object w/ stand dark oxidized** 33"H x 17"W (83x43cm)

SC101 --- N **lasso object w/ stand polished nickel**

SC102 --- **lasso wallpiece w/ steel hook dark oxidized** 25"H x 17"W (64x43cm)

SC102 --- B **lasso wallpiece w/ brass hook brushed brass**

SC102 --- N **lasso wallpiece w/ steel hook polished nickel**

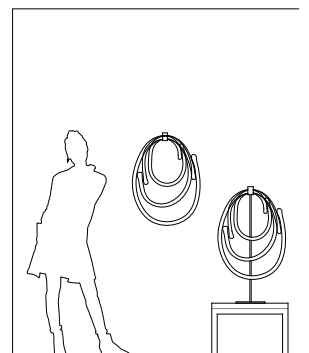



from left: small white, large white



from left: small smoke/new blue, small fire red/morning red, small opal/brown olive and small pea green/sargasso

lava object

SkLO lava are nearly solid glass objects with small blown voids at the top and bottom, each of a contrasting color. The bottoms are ground flat and polished.

Two sizes

Available in five color palettes (including all white)

All glass dimensions are approximate – handblown glass dimensions vary by nature and intent
Handblown in the Czech Republic

available in: fire red/morning red-FMR opal/brown olive-OBO pea green/sargasso-PSG smoke/new blue-SNB white-WHT

VA246 --- lava object small
VA248 --- lava object large

6.5"H x 5"Dia (17x13cm)
13"H x 8"Dia (33x18cm)

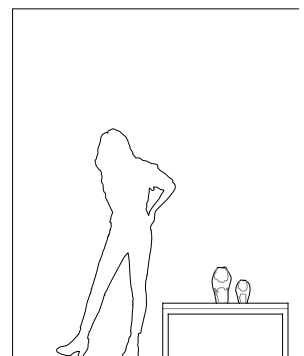



from left: large/tangerine, small/lagoon, large/fuchsia, small/olivin

mantle vessel

SkLO *mantle* vessels are organic spherical vessels with overlapping triple color schemes of two opaque colors cupping a third transparent color void. The colors are encased in thick clear Czech glass, giving the impression of the colors floating individually within the substantial form.

Two sizes

Available in four color palettes

All glass dimensions are approximate – handblown glass dimensions vary by nature and intent
Handblown in the Czech Republic

available in: *fuchsia-FUS lagoon-LAG olivin-OLV tangerine-TNG*

VA731 ---

mantle vessel small

5"Dia (13cm)

VA732 ---

mantle vessel large

8"Dia (20cm)

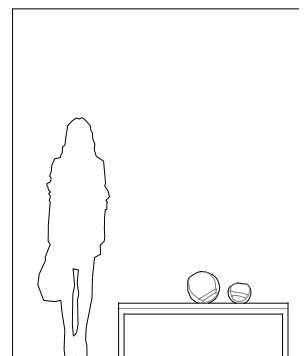

SkLO





from left: 9"Dia/smoke, 9"Dia/yellow, 9"Dia/blue, 9"Dia/purple,
6 1/2"Dia/blue, 6 1/2"Dia/yellow, 6 1/2"Dia/smoke, 6 1/2"Dia/purple

pair vessel

SkLO *pair* vessels are composed of two cylindrical vessels fused together at their bases, making double-ended vessels. Each of the open ends are ground and polished, so that the vessels can be oriented with either end "up" as the open vessel. Each *pair* vessel is composed of two colors, one opaque and one transparent.

Available in eight unique sizes/proportions and four color combinations
All glass dimensions are approximate – handblown glass dimensions vary by nature and intent
Handblown in the Czech Republic

VA300 PYL	pair vessel yellow palette	4.5"H x 6.5"Dia (11x17cm)
VA301 PPR	pair vessel purple palette	6.5"H x 6.5"Dia (17x17cm)
VA302 PSM	pair vessel smoke palette	10"H x 6.5"Dia (25x17cm)
VA303 PBL	pair vessel blue palette	15"H x 6.5"Dia (38x17cm)
VA304 PSM	pair vessel smoke palette	5"H x 9"Dia (13x23cm)
VA305 PBL	pair vessel blue palette	8.5"H x 9"Dia (22x23cm)
VA306 PYL	pair vessel yellow palette	13"H x 9"Dia (33x23cm)
VA307 PPR	pair vessel purple palette	18"H x 9"Dia (46x23cm)

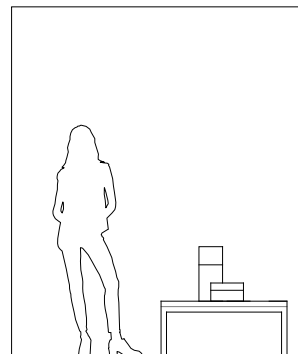

SkLO





top: round pivot shown in blue palette
 bottom from left: small pivot shown in clear, mix palette and blue palette

pivot object

SkLO *pivot* objects are floor or tabletop sculptures composed of spheres and ellipsoids of handblown Czech glass mounted on geometric steel armatures. The glass elements are available in mixed palettes of transparent colors as shown, or in all clear glass.

Glass available in three color palettes (including clear)

Steel armature available in dark oxidized finish only

All glass dimensions are approximate – handblown glass dimensions vary by nature and intent
 Handblown in the Czech Republic

available in: clear-CLR mix palette-MIX blue palette-PBL

SC340 ---

pivot object round

30" Dia (76cm)

SC342 ---

pivot object small

15" Dia (38cm)

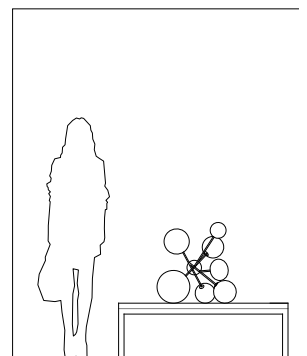



from left: mini gray, medium new blue, large steel blue, small smoke (all with dark oxidized stands), small plum (brushed brass stand)

pool object

SkLO *pool* objects are discs of handblown glass with open mouths at the center where the pieces are broken from the glassmaster's pipe and flame polished, giving each a unique detail. With handmade steel table stands. All sizes available with steel table stands. Medium, small, and mini sizes also available with brass table stands.

Four sizes, nine colors

Steel table stands available in dark oxidized finish only

Brass stands available in brushed brass finish only

All glass dimensions are approximate – handblown glass dimensions vary by nature and intent

Handblown in the Czech Republic

transparent colors:



plum-PLM



smoke-SMK



smokey gray-SMG



steel blue-SBL



strawberry-STB

opaque colors:



light beige-LBE



gray-GRY



new blue-NBL



white-WHT

SC304 ---	pool object mini <i>dark oxidized</i>	12.5"H x 7"W (32x18cm)
SC318 ---	pool object mini <i>brushed brass</i>	
SC308 ---	pool object small <i>dark oxidized</i>	21"H x 12"W (53x30cm)
SC312 ---	pool object small <i>brushed brass</i>	
SC309 ---	pool object medium <i>dark oxidized</i>	24"H x 18"W (61x46cm)
SC313 ---	pool object medium <i>brushed brass</i>	
SC310 ---	pool object large <i>dark oxidized</i>	29"H x 24"W (74x61cm)

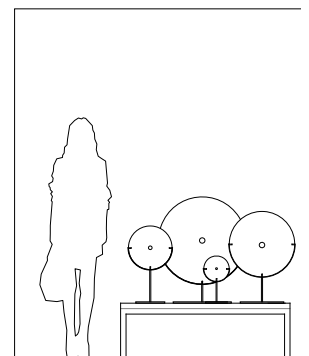



from left: medium/strawberry, small/smoke, large/plum

pool wallpiece

SkLO *pool* wallpieces are discs of handblown glass with open mouths at the center where the pieces are broken from the glass master's pipe and flame polished, giving each a unique detail. SkLO *pool* wallpieces are hung with handmade steel wall hooks. The steel wall hooks come in two different depths, 3" and 4" (7.5 and 10cm) to allow for slight overlapping of the *pool* discs. Unless otherwise specified, a mix of 3" and 4" hooks is provided.

Three sizes, nine colors

Steel wall hooks available in two finishes: dark oxidized / polished nickel

All glass dimensions are approximate – handblown glass dimensions vary by nature and intent

Handblown in the Czech Republic

transparent colors:



plum-PLM

smoke-SMK

smokey gray-SMG

steel blue-SBL

strawberry-STB

opaque colors:



light beige-LBE

gray-GRY

new blue-NBL

white-WHT

SC305 ---	pool wallpiece small <i>dark oxidized</i>	12" Dia (30cm)
SC305 --- N	pool wallpiece small <i>polished nickel</i>	
SC306 ---	pool wallpiece medium <i>dark oxidized</i>	18" Dia (46cm)
SC306 --- N	pool wallpiece medium <i>polished nickel</i>	
SC307 ---	pool wallpiece large <i>dark oxidized</i>	24" Dia (61cm)
SC307 --- N	pool wallpiece large <i>polished nickel</i>	

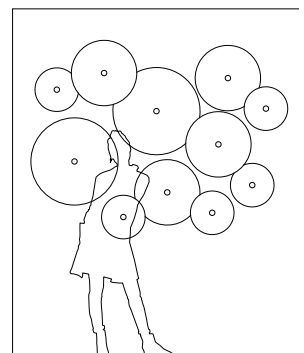

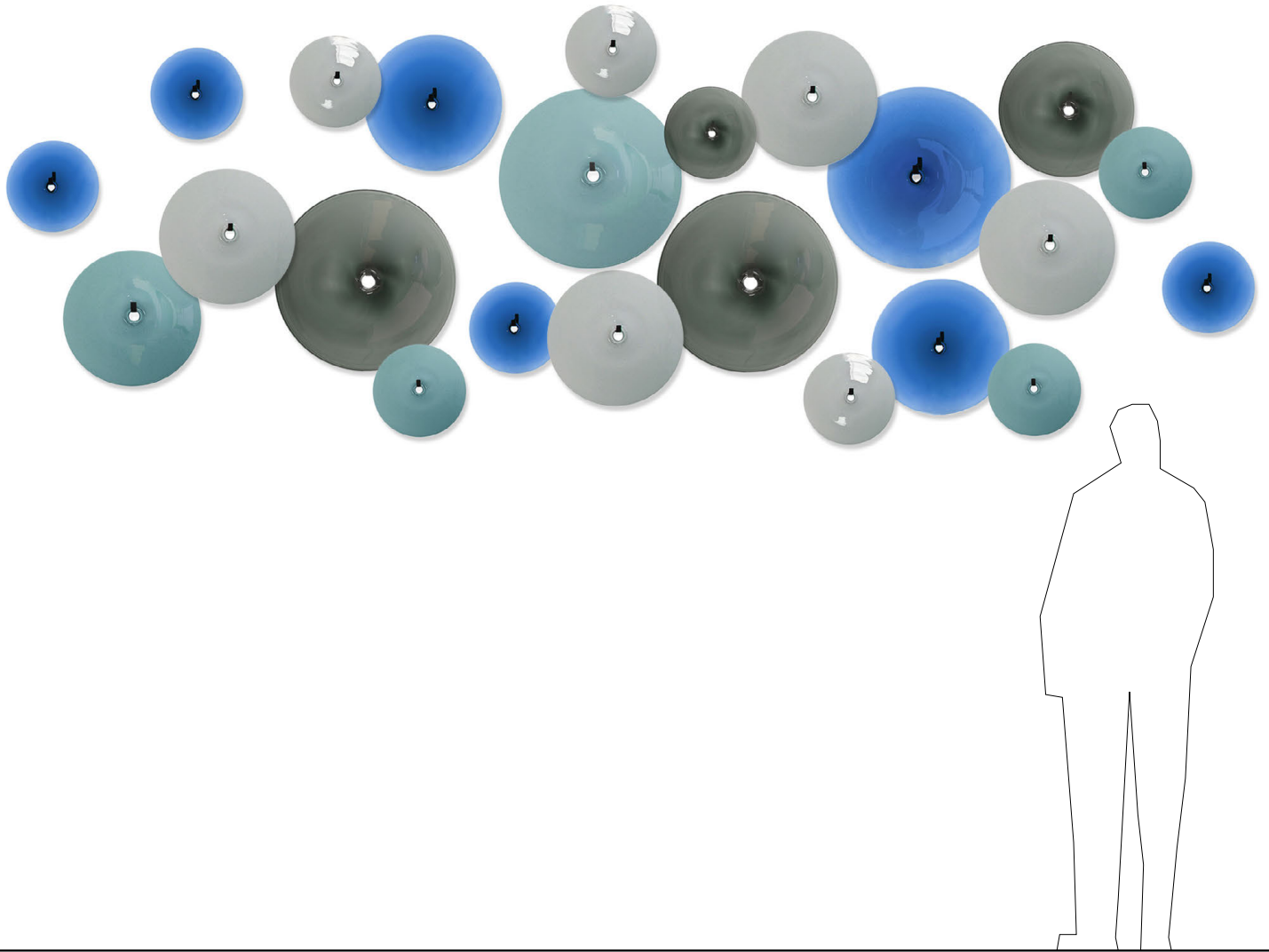

pool wallpiece

A wall-ready composition of SkLO *pool* wallpieces: discs of handblown glass with open mouths at the center where the pieces are broken from the glassmaster's pipe and flame polished, giving each a unique detail. They are hung with handmade steel wall mounts.

Available in size and color composition as shown

Steel wall mounts available in two finishes: dark oxidized / polished nickel

All glass dimensions are approximate – handblown glass dimensions vary by nature and intent

Handblown in the Czech Republic

blue on blue palette



gray-GRY



new blue-NBL



smoke-SMK



steel blue-SBL

SC325PBB pool wallpiece blue on blue palette *dark oxidized* 60"H x 192"W (153x488cm)

SC325PBBN pool wallpiece blue on blue palette *polished nickel*



puddle *vessel/candlestick*

Sculptural Czech glass vases that double as candlesticks with the addition of a handmade solid brass candlecup. Tall and slender with thick bases of solid glass. Each *puddle* is handblown, they have a slight off-center organic movement to the stem, and no two are exactly alike.

Five sizes

Available in clear glass only

All glass dimensions are approximate – handblown glass dimensions vary by nature and intent
Handblown in the Czech Republic

VA001CLR	puddle <i>vessel/candlestick</i> clear	12"H x 6"base (30x15cm)
VA002CLR	puddle <i>vessel/candlestick</i> clear	15"H x 7"base (38x18cm)
VA003CLR	puddle <i>vessel/candlestick</i> clear	23"H x 8"base (58x20cm)
VA004CLR	puddle <i>vessel/candlestick</i> clear	28"H x 8"base (71x20cm)
VA005CLR	puddle <i>vessel/candlestick</i> clear	32"H x 9"base (81x23cm)
CS201BRS	puddle <i>candle cup</i> brushed brass	cup ¾"ID (2cm)

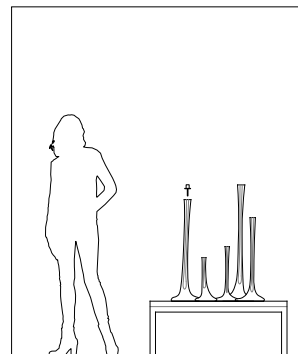



clockwise from left: small/clear, large/steel blue, medium/plum

ring bowl

A broad, shallow bowl of handblown glass that sits freely atop a brass ring base. The handblown glass bowl is blown without the use of a mould – it is shaped by hand while hot on the glass blower's pipe, and it is extra thick and massive as a result. This allows for the lip of the glass bowl to be cut and highly polished. The sturdy brass ring is custom made to fit the bowl, elevating it.

Available in three sizes

Glass available in three colors (including clear). Brass ring available in brushed brass finish only
 All glass dimensions are approximate – handblown glass dimensions vary by nature and intent
 Handblown in the Czech Republic

available in: clear-CLR plum-PLM steel blue-SBL

BL604 --- B	ring bowl small	8"Dia x 4"H (20x10cm)
BL605 --- B	ring bowl medium	10"Dia x 5"H (25x12cm)
BL606 --- B	ring bowl large	16"Dia x 6"H (42x16cm)

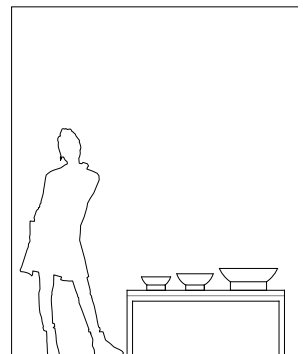

SkLO



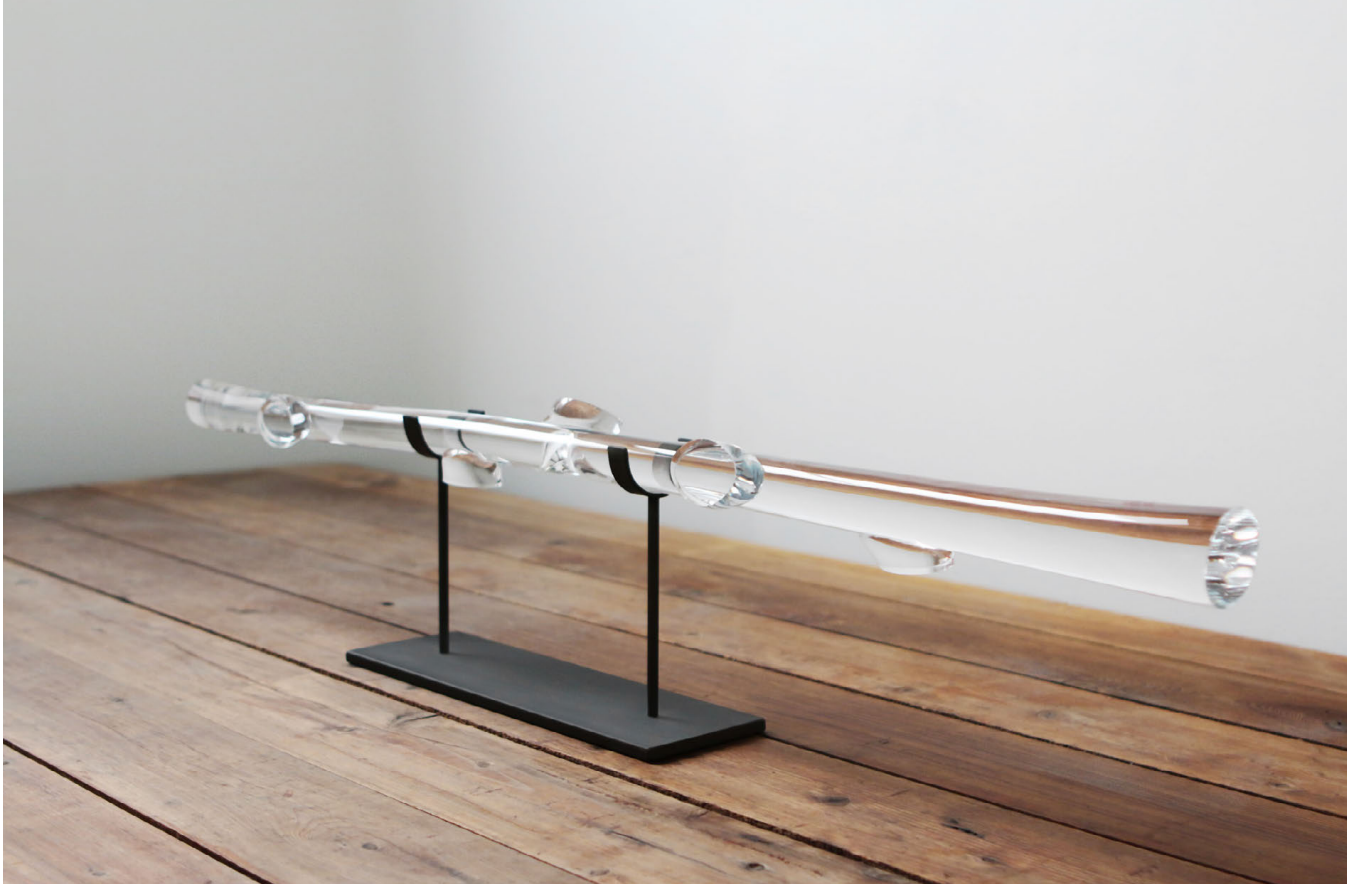

root *object*

Root is a length of solid clear glass, whose length is marked by random locations where glass is organically added, then cut and ground nearly completely off, leaving highly polished and flat cylindrical shapes. Evocative of the shapes of nature, yet also a compelling expression of glass and the skill behind its handmade origins. Includes dark oxidized steel table stand for display.

Available in clear glass only

Stand available in dark oxidized finish only

All glass dimensions are approximate – handblown glass dimensions vary by nature and intent
Handblown in the Czech Republic

SC271CLR

root *object* clear w/ stand

3'-1/2"L x 10"H (93x25cm)

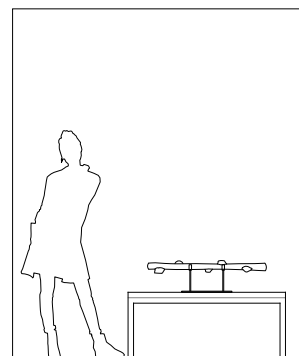



left: gold leaf
right from top: clear, amber, steel blue, white

sea object

SkLO *sea* objects are twists of solid handblown Czech glass with cut and highly polished ends. SkLO *sea* objects are designed to intertwine, and are shown here in intertwined sets of three individual objects.

Available in five colors (including clear)

All glass dimensions are approximate – handblown glass dimensions vary by nature and intent
Handblown in the Czech Republic

available in: clear-CLR amber-AMB gold leaf-GLF steel blue-SBL white-WHT

SC260 ---	sea object single	24"L (60cm)
SC261 ---	sea object set of 3	24"L (60cm)

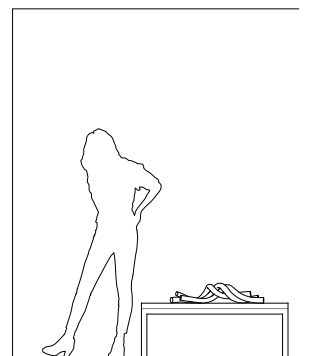



from left: large, medium and small

seam vessel

SkLO *seam* vessels are mirror plated vessels of handblown glass. While hot, the vessels are asymmetrically squeezed and then cut, creating an off-center double mouth at the top. The mouths are ground and polished.

Three sizes

Available in silver mirrored finish only

All glass dimensions are approximate – handblown glass dimensions vary by nature and intent

Handblown in the Czech Republic

VA320SSL	seam vessel small	7.5"H x 10"W (19x25cm)
VA321SSL	seam vessel medium	11"H x 10"W (28x25cm)
VA322SSL	seam vessel large	13"H x 10"W (33x25cm)

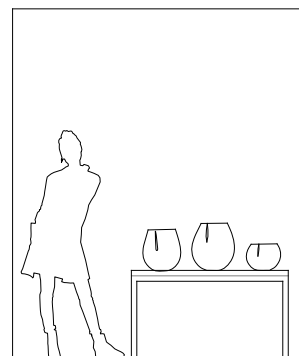



from left: smoke, steel blue, fuchsia, sargasso, pigeon, elephant, flamingo, white

seed vessel

SkLO *seed* vessels are modest organic shapes of solid clear glass, each with a colored glass void blown into the top. The mouths of the vessels are small and polished. The bottoms are ground flat and polished. Intentionally irregular, no two exactly alike.

Eight colors available

All glass dimensions are approximate – handblown glass dimensions vary by nature and intent
Handblown in the Czech Republic

VA310FUS	seed vessel fuchsia	5"H x 3.5"Dia (12x9cm)
VA310SBL	seed vessel steel blue	5"H x 3.5"Dia (12x9cm)
VA310SMK	seed vessel smoke	5"H x 3.5"Dia (12x9cm)
VA310SGR	seed vessel sargasso	5"H x 3.5"Dia (12x9cm)
VA310OBL	seed vessel pigeon	5"H x 3.5"Dia (12x9cm)
VA310ELP	seed vessel elephant	5"H x 3.5"Dia (12x9cm)
VA310FLA	seed vessel flamingo	5"H x 3.5"Dia (12x9cm)
VA310WHT	seed vessel white	5"H x 3.5"Dia (12x9cm)

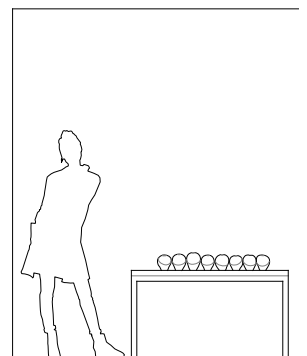



short/smoke



medium/clear



tall/amber

stack object

SkLO stack objects are towers of handblown glass shapes secured on a steel stand.

Glass available in three colors (including clear)

Steel stands available in dark oxidized finish only

All glass dimensions are approximate – handblown glass dimensions vary by nature and intent

Handblown in the Czech Republic

available in transparent colors:



clear-CLR



amber-AMB



smoke-SMK

SC331 ---

stack object short

44"H x 10" square base (112x25cm)

SC332 ---

stack object medium

59"H x 12" square base (150x30cm)

SC333 ---

stack object tall

74"H x 14" square base (189x36cm)

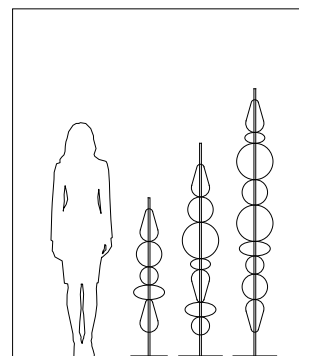



top from left: long sway bowl and high sway bowl, both shown in gray
 bottom from left: olivin, pink, lagoon, white and blue, all long bowls

sway bowl

The SkLO *sway* bowls are asymmetrical organic bowls with amazing depth of color executed in extremely thick Czech glass. Two complementary glass colors are used in each piece to create an amazing and rich color effect. The SkLO *sway* is a timeless design that works within a large range of styles and interiors. The *sway* high bowl is taller and narrower; the *sway* long bowl is an irregular oval. Organically shaped, no two are exactly alike.

Two shapes, six colors

All glass dimensions are approximate – handblown glass dimensions vary by nature and intent
 Handblown in the Czech Republic

available in: blue-BLU gray-GRY lagoon-LAG olivin-OLV pink-PNK white-WHT

BL701 ---	sway bowl high bowl	10" Dia x 5.5"H (25x14cm)
BL703 ---	sway bowl long bowl	20"L x 9"W x 5"H (51x23x13cm)

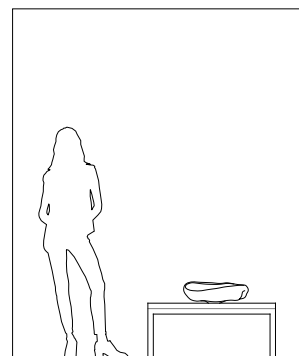



from left: shape 1, shape 2, shape 3, shape 4 and shape 5

taper vessel

Double-sided vessels composed of tapering conical shapes joined together at their narrowest points. Using moulds to blow the individual glass shapes allows careful control over the exact sizes and proportions of the finished piece. Each half of each unique taper vessel is a different transparent color, and the color palette of the entire collection carefully repeats itself to insure multiple vessels always work together as a composition. Each end is open so that the vessels are entirely functional and reversible – the open ends are cut and finish polished. Five unique shapes, in a palette of carefully curated colors. Handblown in the Czech Republic.

Five unique shapes, colors available only as shown

All glass dimensions are approximate – handblown glass dimensions vary by nature and intent
Handblown in the Czech Republic

VA751SGS	taper vessel shape 1 <i>sargasso/gray</i>	10”H x 7”Dia (26x19cm)
VA752SKB	taper vessel shape 2 <i>gray/smoke</i>	16”H x 6”Dia (42x16cm)
VA753SGP	taper vessel shape 3 <i>sargasso/plum</i>	30”H x 12”Dia (76x30cm)
VA754SKP	taper vessel shape 4 <i>smoke/plum</i>	24”H x 9”Dia (62x23cm)
VA755SMS	taper vessel shape 5 <i>sargasso/smoke</i>	18”H x 8”Dia (45x21cm)
VA756MIX	taper vessel set of 5	

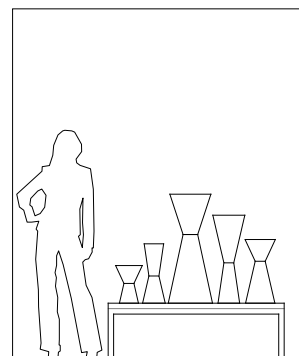

SkLO





back row from left: large/smoke, large/plum and large/fuchsia
front row from left: small/copper ruby, small/sargasso and small/pine tree green

view bowl

The view bowl is created by combining two separate shapes while hot on the glass blower's pipe. The form of the bowl is pressed against a cylindrical base, the rounded surface of the bowl pushing into the space within the cylinder. The tops and bottoms are then cut and polished. Each view bowl is made up of two transparent colors, one for the bowl and one for the base, creating a complex color relationship. The view bowl is available in two different sizes. Each size is available in three unique color palettes. Handblown in the Czech Republic.

Two sizes, colors available only as shown

All glass dimensions are approximate – handblown glass dimensions vary by nature and intent
Handblown in the Czech Republic

small available in: copper ruby-COP pine tree green-TRQ sargasso-SGR

large available in: fuchsia-FUS plum-PLM smoke-SMK

BL731 ---	view bowl small	12" Dia x 9"H (30x22cm)
BL732 ---	view bowl large	16" Dia x 11"H (41x29cm)

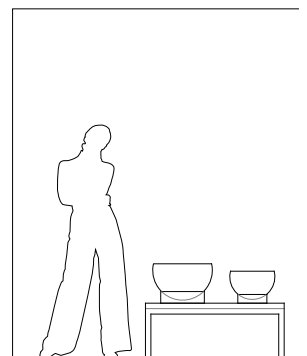

SkLO





clockwise from left: lagoon, smoke, steel blue, amber, clear, fuchsia, purple



clockwise from left: gray, apricot, white, new blue, dark green, celadon green

wrap object

SkLO *wrap* objects are a wound length of handblown Czech glass tube. Each SkLO *wrap* object is a unique handmade piece, no two exactly alike. Whether alone, in threes, or in larger groups, *wrap* presents a distinct opportunity to display the beauty and immediacy of glassblowing.

Available in seven transparent, and six opaque colors

All glass dimensions are approximate – handblown glass dimensions vary by nature and intent
Handblown in the Czech Republic

available in transparent: amber-AMB clear-CLR fuchsia-FUS lagoon-LAG purple-PUR smoke-SMK steel blue-SBL

available in opaque: apricot-APR celadon green-CEL dark green-DRG gray-GRY new blue-NBL white-WHT

FL114 ---

wrap object

7" Dia (18cm)

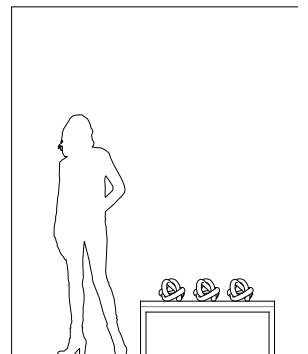

SkLO





wrap large *object*

SkLO *wrap* objects are a wound length of handblown Czech glass tube. Each SkLO *wrap* object is a unique handmade piece, no two exactly alike. Whether alone, in threes, or in larger groups, *wrap* presents a distinct opportunity to display the beauty and immediacy of glassblowing.

Available in seven colors

All glass dimensions are approximate – handblown glass dimensions vary by nature and intent
Handblown in the Czech Republic

transparent colors:



clear-CLR



amber-AMB



smoke-SMK



steel blue-SBL

opaque colors:



gray-GRY



new blue-NBL



white-WHT

FL120 - - -

wrap large *object*

10" Dia (25cm)

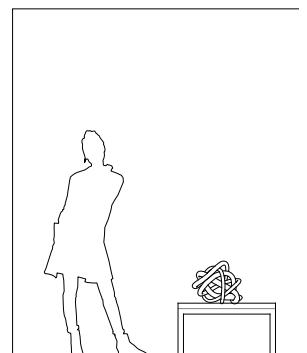



wrap large silver *object*

SkLO *wrap* objects are a wound length of handblown Czech glass tube. Each SkLO *wrap* object is a unique handmade piece, no two exactly alike. This wrap is mirror plated from the inside, giving it its distinct metallic reflective surface. Whether alone, in threes, or in larger groups, *wrap* presents a distinct opportunity to display the beauty and immediacy of glassblowing.

All glass dimensions are approximate – handblown glass dimensions vary by nature and intent
Handblown in the Czech Republic

FL120SLV

wrap large silver *object*

10" Dia (25cm)

