



SKLO INSTALLATION INSTRUCTIONS: DRAPE SKIRT 18 CHANDELIER

GLOVES (NITRILE) ARE PROVIDED AND **MUST** BE WORN DURING INSTALLATION TO AVOID FINGERPRINTS ON THE FINISH OF THE EXPOSED METAL PARTS.

This product must be installed in accordance with the applicable codes by a person familiar with the construction and operation of the product and the hazards involved, preferably a licensed electrician. Use maximum 7W bulb.

Two people are recommended to correctly install this light fixture.

You will require a level for this installation.

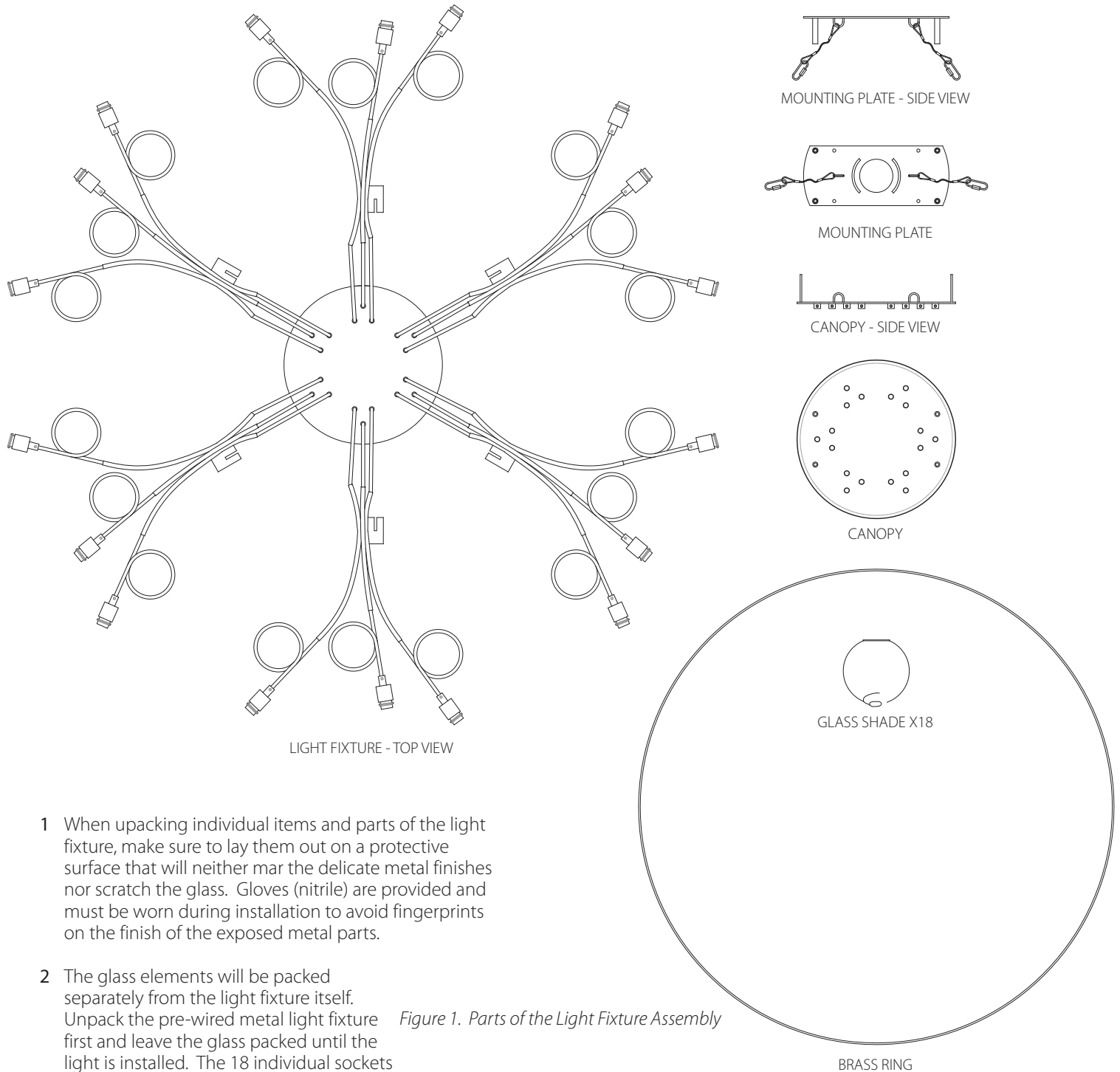

- 1 When unpacking individual items and parts of the light fixture, make sure to lay them out on a protective surface that will neither mar the delicate metal finishes nor scratch the glass. Gloves (nitrile) are provided and must be worn during installation to avoid fingerprints on the finish of the exposed metal parts.
- 2 The glass elements will be packed separately from the light fixture itself. Unpack the pre-wired metal light fixture first and leave the glass packed until the light is installed. The 18 individual sockets and the 6 "skirt" elements will have a protective packaging around them - leave this on until the light is fully installed.



3 The mounting plate will arrive fastened to the canopy. Separate the mounting plate from the canopy by carefully removing the four machine screws and set these aside for use during final installation. NOTE: There are steel cable(s) attached to the mounting plate. The other end of the cable will be attached to the top of the canopy during this installation. Do not remove this cable(s). This cable is provided as part of a UL requirement that allows the fixture to be temporarily suspended independent of the electrical cables/connections for inspection - **Remove the glass spheres before any such inspection or any other case in which the fixture will be supported from this cable alone. Failure to do so will risk breaking the glass.**

4 (Figure 2) Position the mounting plate over the recessed electrical box. The mounting plate can be fastened to a steel 4" electrical box through the curved slots with two 1" steel 8/32 thread machine screws (provided) as a means of temporarily supporting the plate while orienting the fixture and marking the locations of the other four fasteners. Note that the fixture cannot be supported from the electrical box alone. Fasteners/anchors (not provided) that are appropriate to the ceiling material being fastened to and adequate to support the weight of the fixture **MUST** be installed in all four fastener holes provided in the mounting plate.

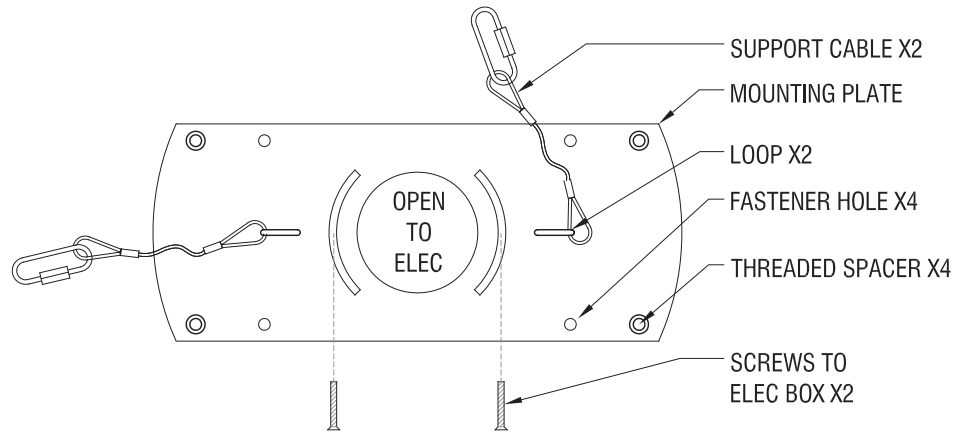

Figure 2. Install mounting plate

5 Fully thread each of the provided four nylon all-thread rods into each of the four threaded stand-offs on the mounting plate (Figure 3). Supporting the light fixture, slide the canopy up and over the four nylon all-thread rods such that each rod passes through the appropriate hole in the canopy (Figure 4). One at a time, slide a nylon washer up over each all thread and thread on a wing nut. When all four wing nuts are securely in place on the all-thread rods, the fixture can then carefully rest on the washers. It is best to locate the canopy on the all-thread rods such that it is close enough to the ceiling to allow for connecting the wiring from the canopy to the electrical box and for the support cable to reach from mounting plate to canopy, but low enough to allow comfortable access. Note: Do not adjust the set screws in the strain reliefs where each cord enters the canopy.

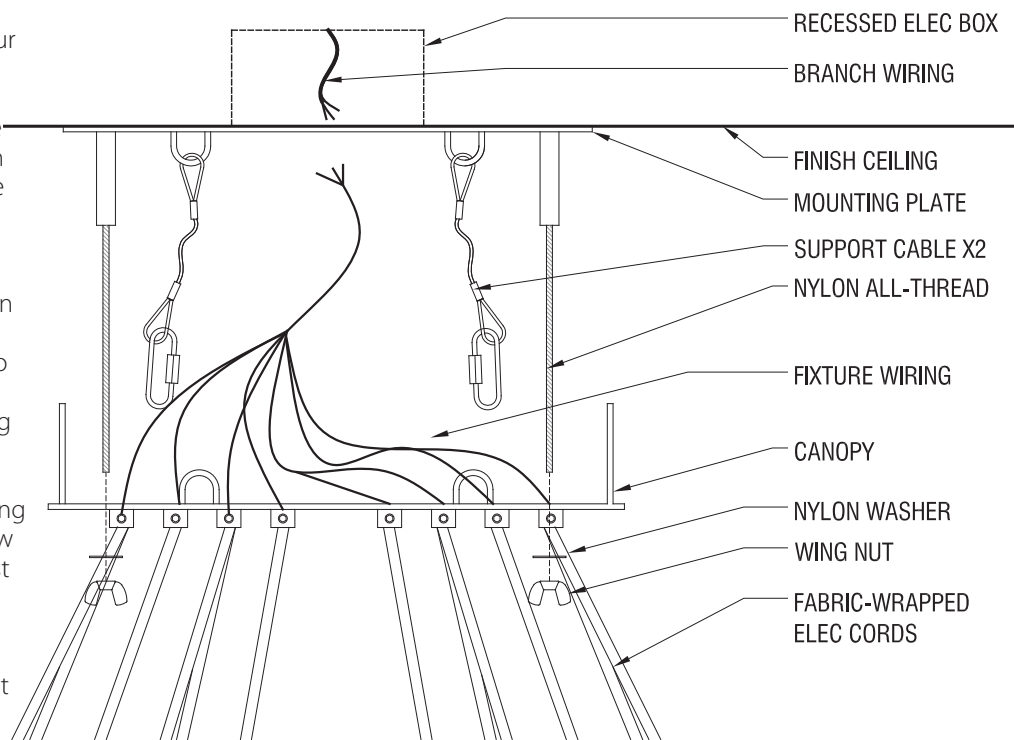

Figure 4. Install nylon all-thread rods into mounting plate and slide canopy up over rods

6 With the light fixture supported, connect the exposed leads of the fixture to the leads in the electrical box according to the wiring diagram (Figure 4). Use suitable wire connectors.

7 Attach the support cable(s) to the loop(s) on the inside/top of canopy by means of the provided quick-link at the free end of the cable (Figure 5).

8 Raise canopy and carefully supported fixture up the nylon all-thread rods all the way flush to the ceiling taking care that no electrical cables or connections are exposed where canopy meets ceiling. Working one at a time, remove a nylon all-thread rod and insert one of the provided machine screws through the countersunk hole in the canopy into the corresponding threaded stand-off on the mounting plate above. Take great care when installing machine screws so that tools do not slip and scratch the canopy finish, nor damage the exposed screw head slots.



- 9 Unwrap the protective packaging from each of the 6 brass "skirt" elements. Install the slotted ring by positioning it with the slots facing down and then working one at a time, carefully fit slot the tab on each "skirt" into the corresponding slot on the ring (Figure 5). The "skirts" were positioned at the correct height during your fixture's assembly, but some slight adjustments may be necessary to get the bar level and the cords visually taut above the "skirts". The cords are loose within the tubes of the "skirts" and can be gently adjusted slightly up and down, but be extremely careful and make no more adjustments than are necessary to achieve a level ring.
- 10 Unwrap the protective packaging from each of the 18 individual pendants. Install a light bulb in each socket. Unwrap and lay out the 18 individual glass spheres. Carefully thread a glass sphere onto each socket (Figure 6). Thread the glass spheres on just until they are visually tight - do not overtighten or the sockets can bind and the brass assembly on the glass sphere can loosen.
- 11 Installation is complete. See example of completed fixture (Figure 7).

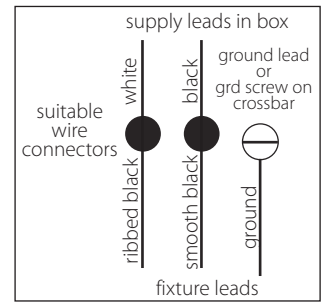

Figure 4. Wiring Diagram

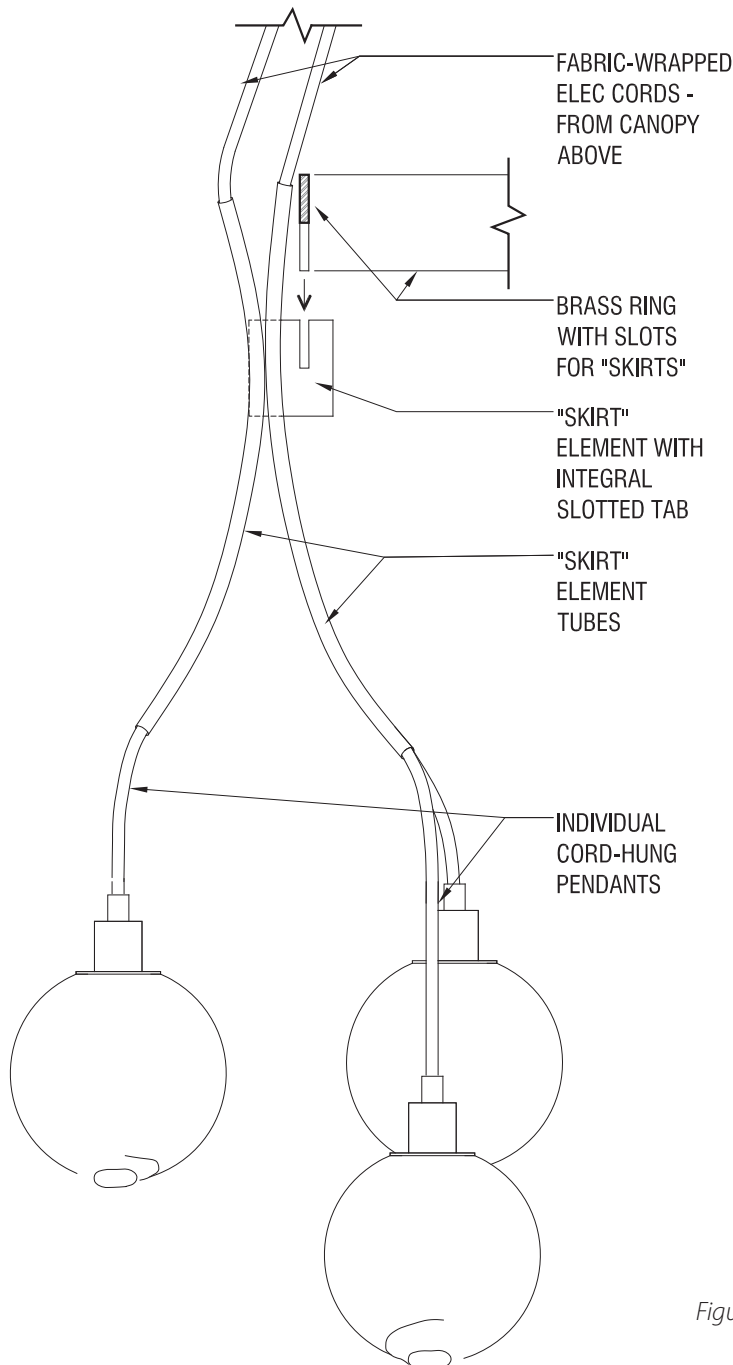

Figure 5. Install ring into "skirt" elements

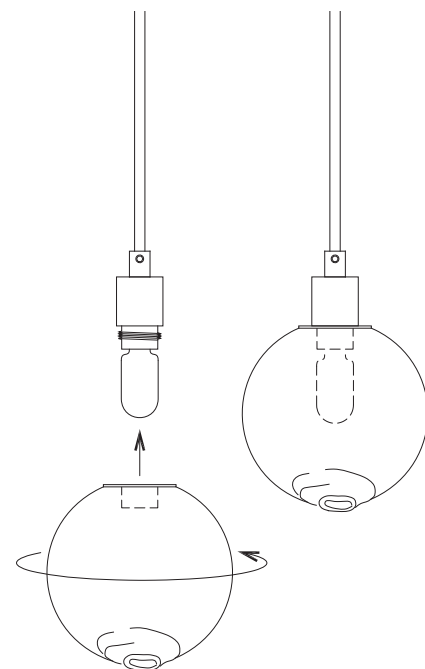

Figure 6. Install glass shades by threading onto brass sockets

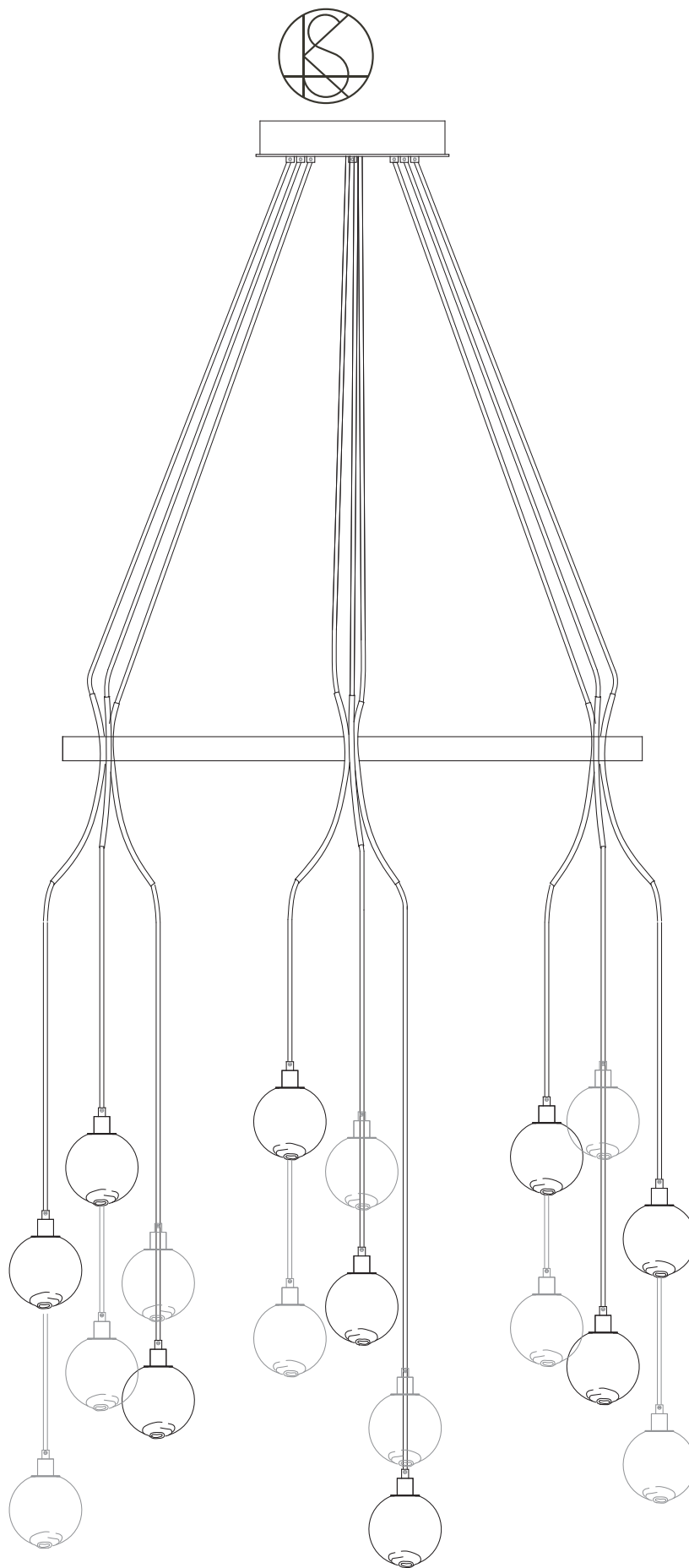

Figure 7. Side view of a completed fixture