

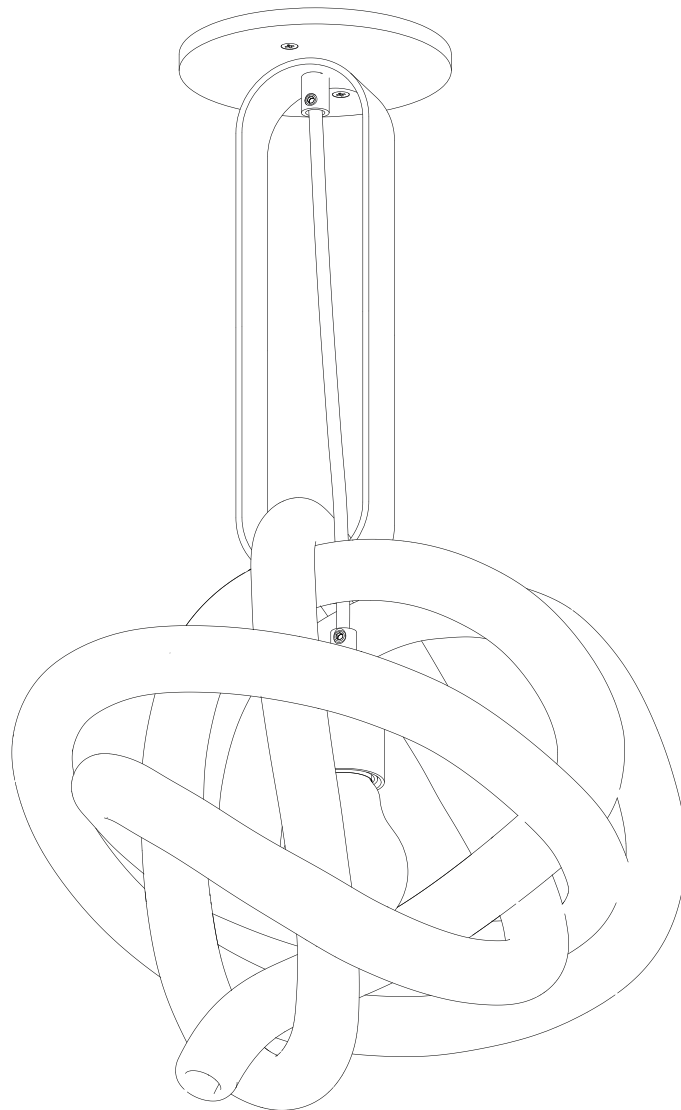

# WRAP PIN 1.09 PENDANT

## Installation Instructions



**SkLO**

sklo.com

SkLO US 115 WEST NORTH STREET HEALDSBURG CALIFORNIA 95448 USA +1.707.385.2101 us@sklo.com  
SkLO EU VÁŽNÍ 488 500 03 HRADEC KRÁLOVÉ CZECH REPUBLIC +420.495.542.071 eu@sklo.com



# WRAP PIN 1.09 PENDANT

Congratulations on your purchase of a SkLO Wrap Pin 1.09 Pendant. This product must be installed in accordance with the applicable codes by a person familiar with the construction and operation of the product and the hazards involved, preferably a licensed electrician. Use a maximum 60W bulb.

**When unpacking individual items and parts of the light fixture, make sure to lay them out on a protective surface that will neither mar the delicate metal finishes nor scratch the glass. Gloves (nitrile) are provided and must be worn during installation to avoid fingerprints on the finish of the exposed metal parts.**

Your SkLO fixture will arrive with the hand-blown glass elements packed separately from the light fixture itself.

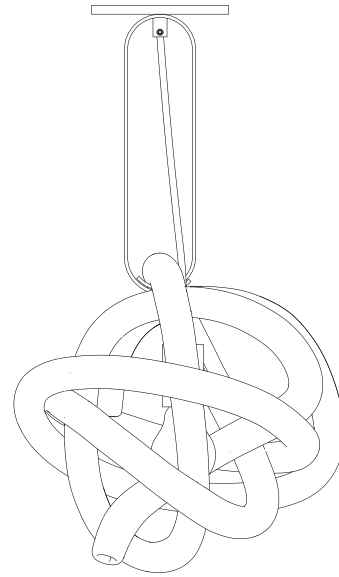

## CONTENTS:

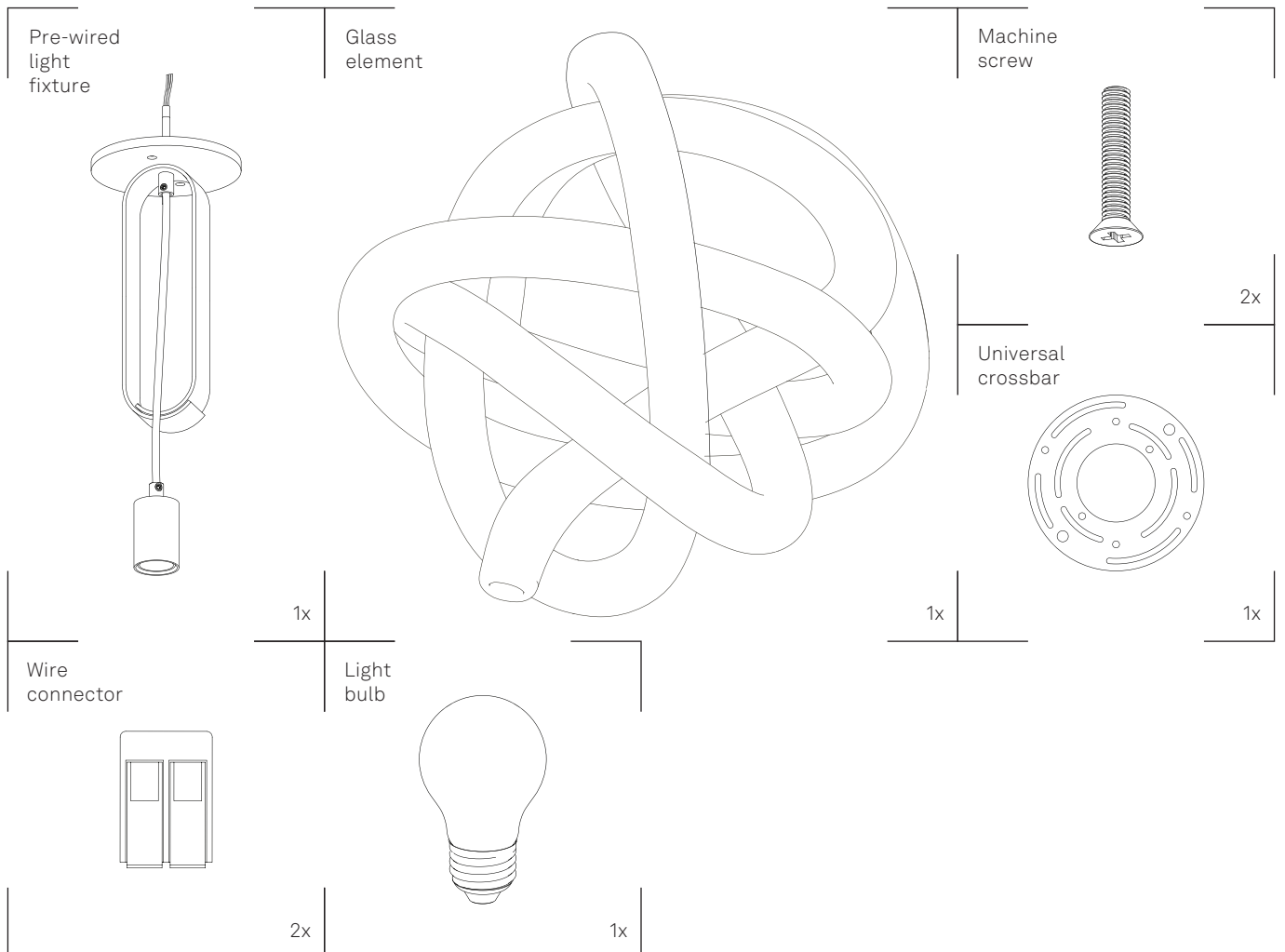



1. The canopy and the 'pin' will come pre-assembled and wired with the fabric-wrapped electrical cord and the brass socket. Please do not remove the protective packaging from the brass socket and leave the fabric-wrapped electrical cord tied in a loop during installation and wiring.
2. Install the universal crossbar (provided) to the recessed electrical box with the 8/32 thread screws so that the 8/32 threaded holes spaced 2 3/4" on-center on the crossbar match the desired orientation of the fixture based on the countersunk holes in the canopy (Figure 1).
3. Carefully supporting the fixture, connect the exposed leads of the fixture to the exposed leads in the electrical box, following the wiring diagram and using the provided wire connectors. Attach the ground (TE) wires to ground (TE) wires of the light fixture, phase 1 (L1) to phase 1 (L1) of the light fixture, neutral (N) to neutral (N) of the light fixture (Figure 2). Please note the number and type of wire connectors may vary.
4. The canopy installs directly to the crossbar. The back of the canopy is recessed to fit over the crossbar and to sit flush against the ceiling finish surface. Take care that no electrical cables or connections are exposed where the canopy meets the ceiling. Fasten the canopy by screwing the two provided 1" long 8/32 thread machine screws directly into the 8/32 threaded holes spaced 2 3/4" on-center on the crossbar through the countersunk holes provided in the canopy, making sure that the canopy sits flush against the ceiling finish surface (Figure 3). Take great care when installing machine screws so that tools do not slip and scratch the canopy finish, or damage the exposed screw head slots.
5. Uncoil and gently straighten out the fabric-wrapped electrical cord, then carefully unwrap the brass socket.
6. Install the supplied LED light bulb (60W Max) into the socket (Figure 4).
7. Open the bottom of the 'pin' element. Gently but firmly pull the two overlapping sides apart until the 'pin' pops open. Insert the socket with the light bulb carefully within the glass element, then carefully slip the glass up into the 'pin' and gently but firmly push the 'pin' closed again. Once the 'pin' is closed around the glass, carefully allow the glass to hang from the bottom of the 'pin' (Figure 5). Note that there are several ways to attach the glass to the 'pin', and you should choose one that works well before inserting it into the 'pin'. Note that some scratching of the finish may occur from the opening or closing of the 'pin', but these will only be visible when the 'pin' is open and will not affect the rest of the finish on the piece.

1.

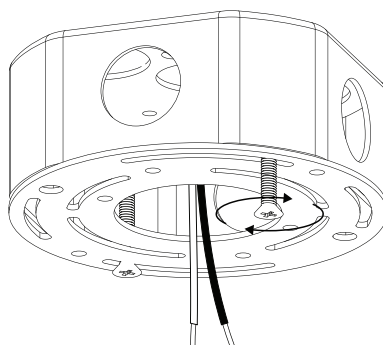



2.

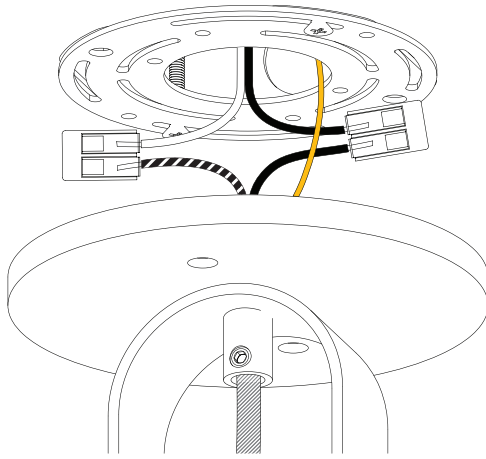

3.

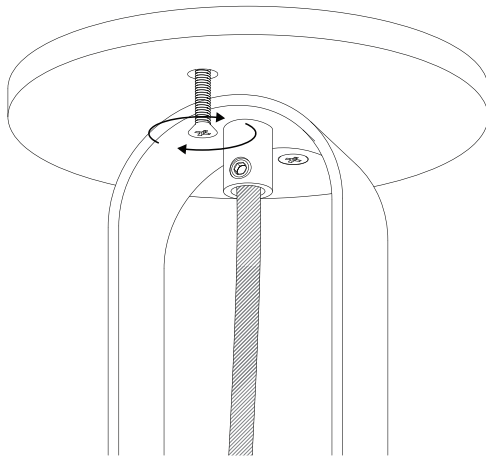

4.

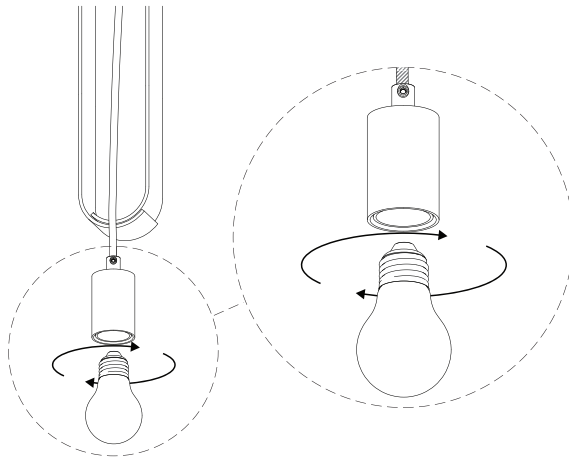

5.

