

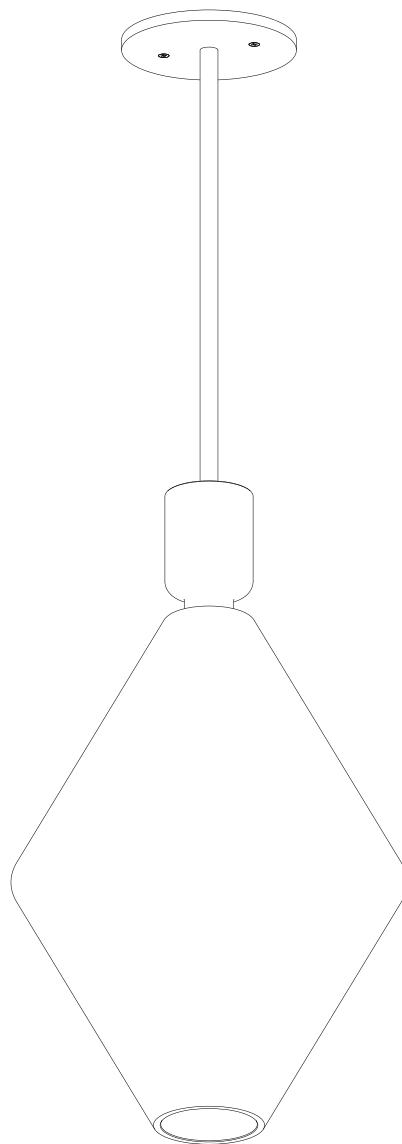

# REFLECT PENDANT

## Installation Instructions



**SkLO**

sklo.com

SkLO US 115 WEST NORTH STREET HEALDSBURG CALIFORNIA 95448 USA +1.707.385.2101 us@sklo.com  
SkLO EU VÁŽNÍ 488 500 03 HRADEC KRÁLOVÉ CZECH REPUBLIC +420.495.542.071 eu@sklo.com



# REFLECT PENDANT



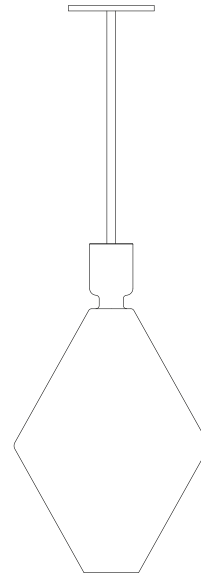

*Congratulations on your purchase of a SkLO Reflect Pendant. This product must be installed in accordance with the applicable codes by a person familiar with the construction and operation of the product and the hazards involved, preferably a licensed electrician. Use a maximum 60W bulb.*

**When unpacking individual items and parts of the light fixture, make sure to lay them out on a protective surface that will neither mar the delicate metal finishes nor scratch the glass. Gloves (nitrile) are provided and must be worn during installation to avoid fingerprints on the finish of the exposed metal parts.**

*Your SkLO fixture will arrive with the hand-blown glass elements packed separately from the light fixture itself.*

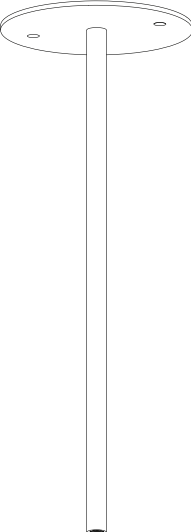

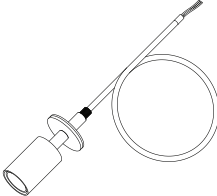
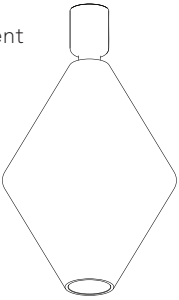
## CONTENTS:

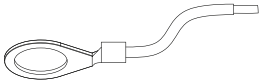
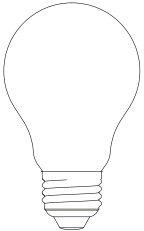
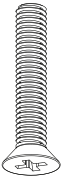
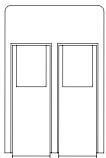
<p>Canopy + stem</p> 	<p>Additional stem segment (longer OAD lengths only)</p> 	<p>Cord + lamp socket cup</p> 	<p>Glass element</p>  <p>1x</p> <p>Hexagonal nut</p>  <p>1x</p> <p>Lock washer</p> 
<p>Ground lug</p>  <p>1x</p>	<p>Light bulb</p>  <p>quantity varies</p>	<p>Machine screw</p>  <p>1x</p>	<p>Wire connector</p>  <p>1x</p> <p>2x</p> <p>2x</p>



1. Uncoil the electrical wiring at the top of the fixture and carefully pass the wires through the stem. Then, attach the female/internally threaded stem to the fixture by threading the open end of the stem onto the exposed threaded nipple on the top of the fixture (Figure 1).

For lights with longer OAD lengths, the stem will be in multiple parts. Uncoil the electrical wiring at the top of the fixture and carefully pass the wires through each stem as you fasten them together. To connect the stems, first, attach one of the lengths of the stem to the fixture by threading the open female/internally threaded end of the stem onto the exposed threaded nipple on the top of the fixture (Figure 1). Then, attach the remaining stem lengths by threading the open end of each stem onto the exposed nipple of the other (Figure 2).

2. Install the supplied LED light bulb (60W Max) into the socket. Light bulb installation and removal can be done by carefully lifting the glass shade up the stem and over the bulb. Before attaching the canopy, carefully slide the stem up through the glass shade (Figure 3) such that the glass will rest on the rubber washer on the top face of the disc above the socket (Figure 4).
3. With the glass over the stem, now attach the canopy by passing the electrical leads and threaded nipple at the top of the stem through the center hole in the canopy. Working from the top/inside of the canopy, slide the lock washer over the nipple, followed by the ground lug, then thread on the provided nut (Figure 5).

4. Carefully supporting both the glass and the fixture, connect the exposed leads of the fixture to the exposed leads in the electrical box, following the wiring diagram and using the provided wire connectors. Attach the ground (TE) wires to ground (TE) wires of the light fixture, phase 1 (L1) to phase 1 (L1) of the light fixture, neutral (N) to neutral (N) of the light fixture (Figure 6). Please note the number and type of wire connectors may vary.
5. This fixture requires an electrical box with available holes at 3 1/2" on center spacing. If a box with differently spaced threaded holes is present, additional parts may be required to install the fixture properly, such as a universal crossbar (not supplied).

Raise the canopy all the way flush to the ceiling, taking care that no electrical cables or connections are exposed where the canopy meets the ceiling. Install light by fastening the two supplied 8/32 thread brass machine screws directly into the appropriate holes in the electrical box through the holes provided in the canopy (Figure 7). Take great care when installing screws so that tools do not slip and scratch the canopy finish, or damage the exposed screw head slots. Make sure that the glass element is securely resting on the rubber washer/disc.



1.

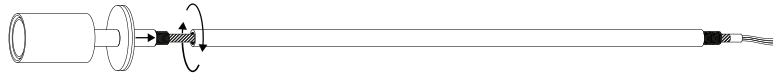

2.

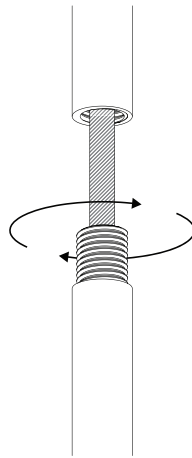

3.

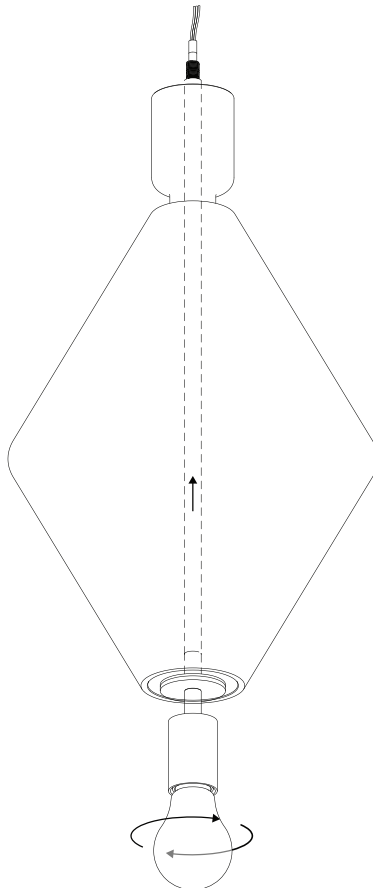



4.

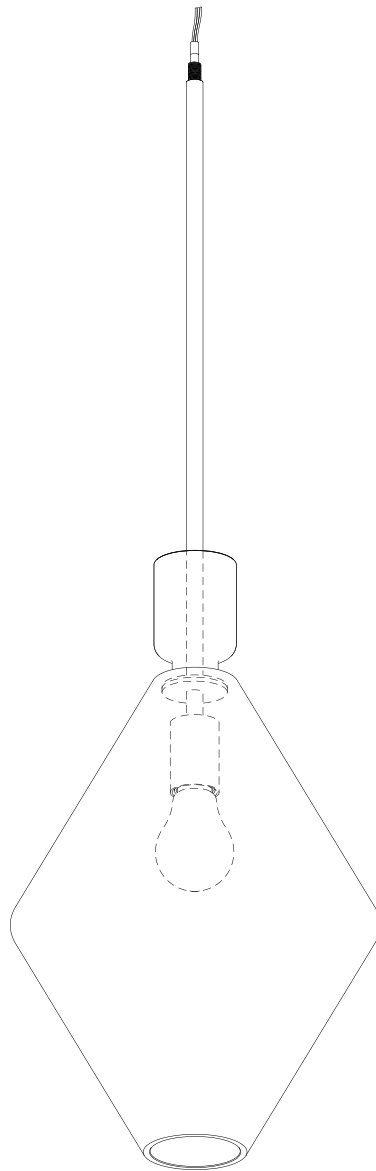



5.

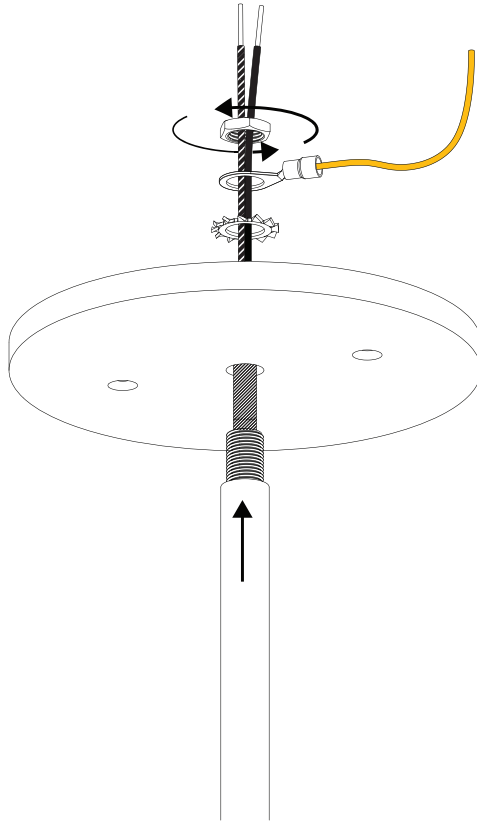

6.

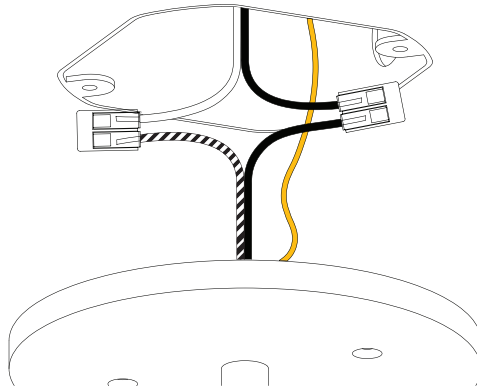

7.

