



STACK OBJECT SHORT

Installation Instructions

Congratulations on your purchase of a SkLO Stack Object Short.

When unpacking individual items and parts of the object, make sure to lay them out on a protective surface that will neither mar the delicate metal finishes nor scratch the glass. Gloves (nitrile) are provided and must be worn during installation to avoid fingerprints on the finish of the exposed metal parts.

Your SkLO object will arrive with the hand blown glass elements packed separately from the light fixture itself.

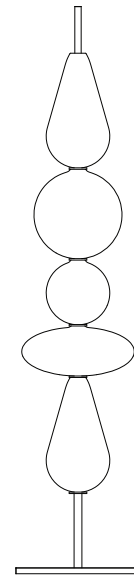

CONTENTS:

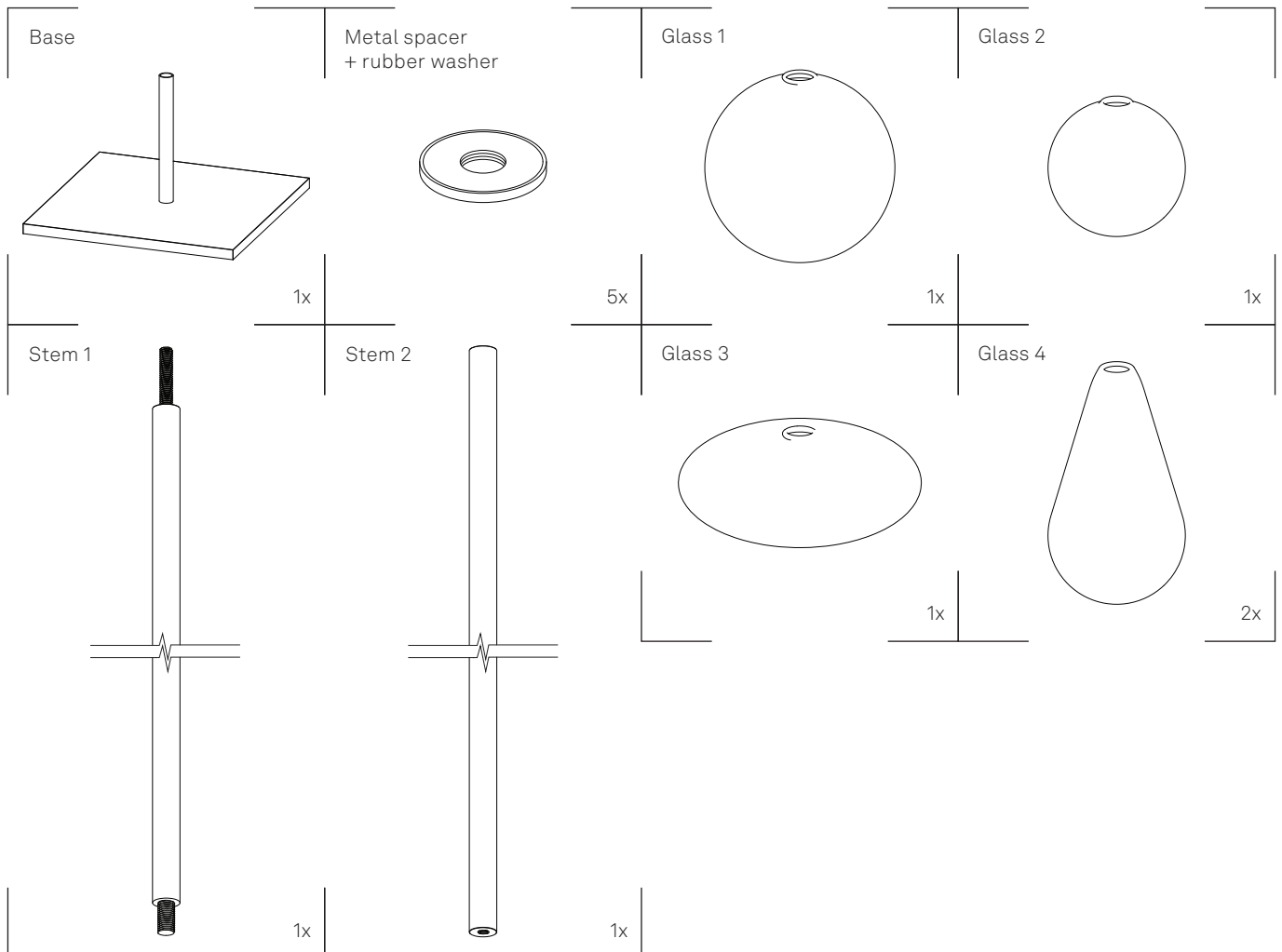



1. Carefully feed the Stem 1 through the central tube on the base and thread it in the thread at the bottom of the tube. Thread until tight. (Figure 1)
2. Connect the Stem 2 to Stem 1 by threading the female/ internally threaded end of the stem onto the exposed threaded nipple on the top of the Stem 1. Thread until tight. (Figure 2).
3. Slide one of the provided spacers with rubber washer over the stand assembly. Carefully slide it down until it sits on the central tube of the base. (Figure 3)
4. Unwrap and lay out five glass pieces. Carefully slide one of the glass pieces over the stand assembly until it sits on the spacer. (Figure 4). Repeat the process until you get the complete composition of the object. Do not forget to slide one spacer between each and every glass piece! (Figure 5)
5. To get the correct composition follow the glass order in (Figure 6)



1.

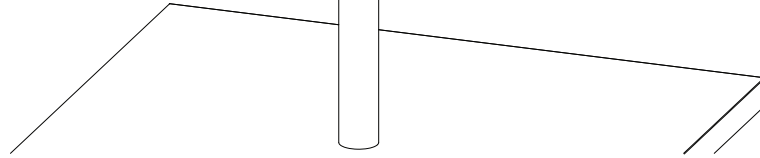
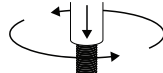

2.

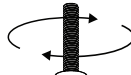

3.

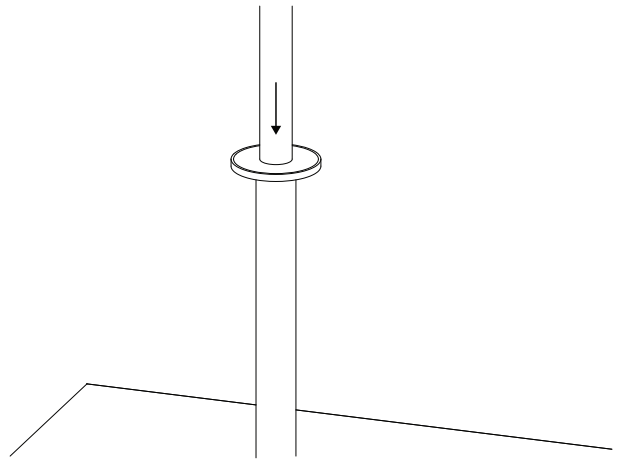

4.

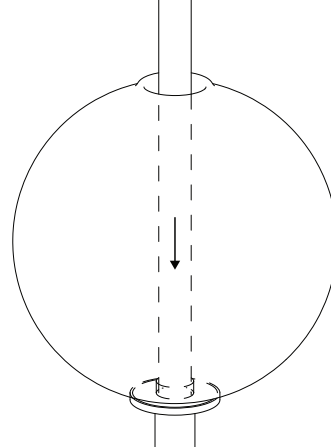
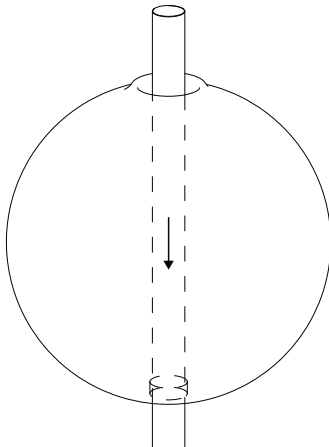



5.

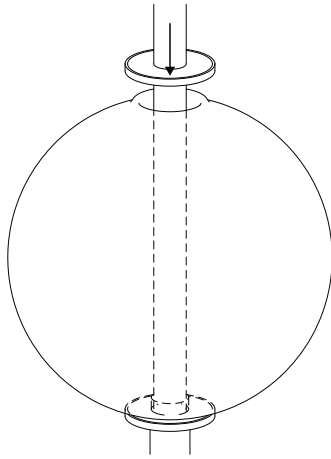

6.

Glass 4

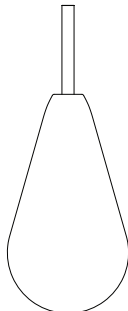

Glass 1

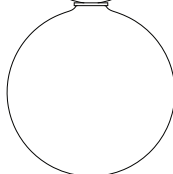

Glass 2

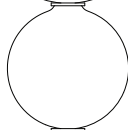

Glass 3

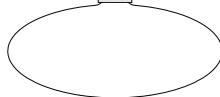

Glass 4

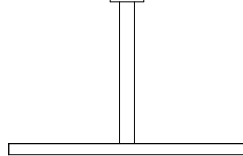
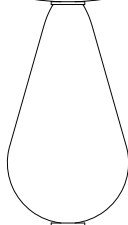

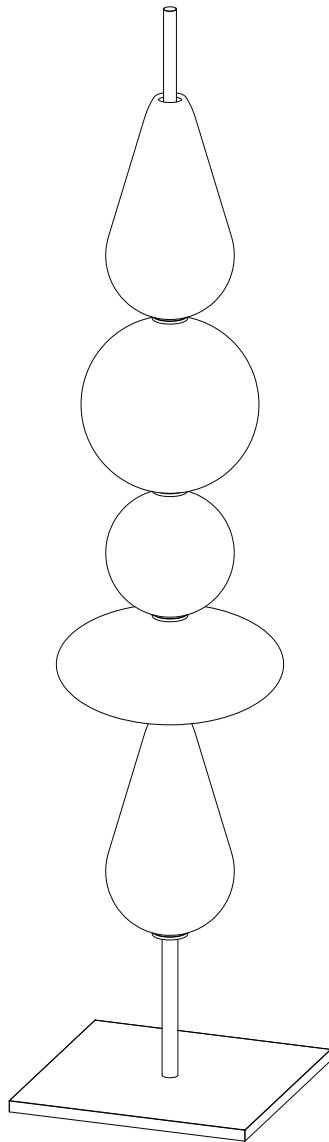

SkLO

sklo.com

SkLO US 115 WEST NORTH STREET HEALDSBURG CALIFORNIA 95448 USA +1.707.385.2101 us@sklo.com
SkLO EU VÁŽNÍ 488 500 03 HRADEC KRÁLOVÉ CZECH REPUBLIC +420.495.542.071 eu@sklo.com